

Washing machine
Lave-linge
Wasmachine
Lavadora

10003288 - WF 612 C W566C2

INSTRUCTIONS FOR USE02
CONSIGNES D'UTILISATION30
GEBRUIKSAANWIJZINGEN60
INSTRUCCIONES DE USO88

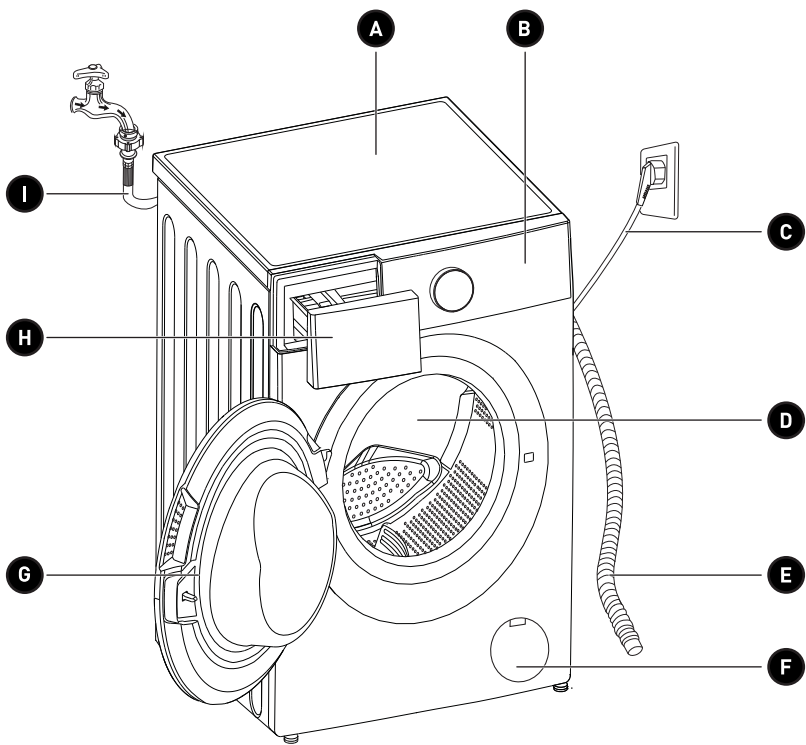



J



K



L



Thank you!

Thank you for choosing this VALBERG product. VALBERG products are chosen, tested, and recommended by ELECTRO DEPOT, so you can be sure you are getting a top-quality, easy-to-use product that won't let you down.

We're confident your new device will be a pleasure to use every day!

Welcome to ELECTRO DEPOT.



ELECTRO DEPOT

Table of Contents

A

Product overview

Parts
Specifications

B

Product usage

Installation
Operation

C

Cleaning and maintenance

Cleaning and maintenance
Trouble Shooting
Transport

Product Fiche

Parts

A Top cover

B Control panel

C Power supply cord

D Drum

E Drain hose

F Service flap

G Door

H Detergent dispenser

I Water supply hose

J 4 x Cover caps

K 1 x Supply hose cold water

L Acoustic sponge



Note:

- The product picture is for illustration only, please refer to real product as reference.

Specifications

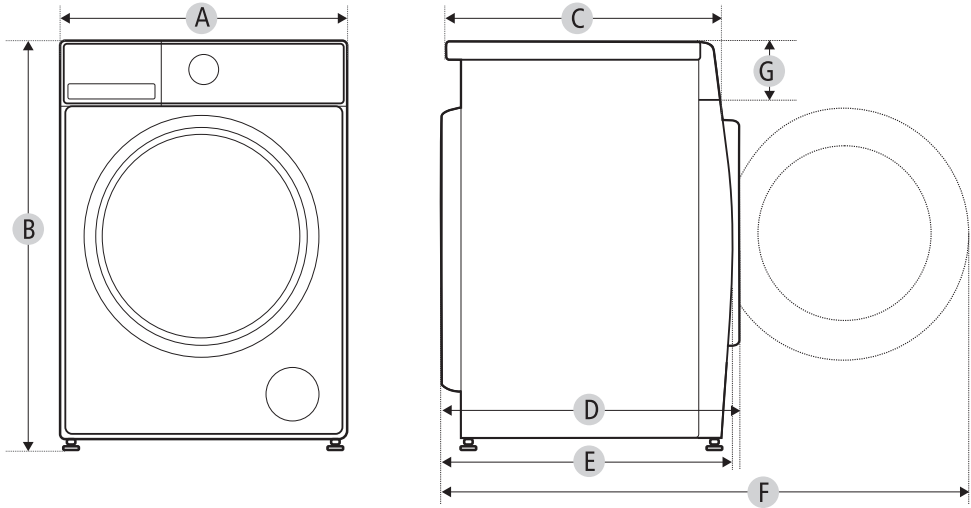

Model:	10003288 - WF 612 C W566C2
Power Supply:	220-240V~,50Hz
MAX. Current:	10A
Standard Water Pressure:	0.05MPa~1MPa
Washing Capacity:	6.0kg

Dimension

A:	595mm
B:	850mm
C:	400mm
Weight:	55kg
Rated Power:	1950W

Reference Dimension

D:	463mm
E:	421mm
F:	897mm
G:	152mm

Installation

Installation area

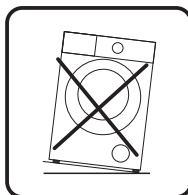
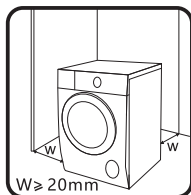

Warning!

- Stability is important to prevent the product from wandering! Make sure the machine is standing leveled and stable.
- Make sure that the product does not stand onto the power cord.
- Make sure to maintain the minimum distances from the walls as shown in the picture.

Before installing the machine, the location characterized as follows shall be selected:

- Rigid, dry, and level surface
- Avoid direct sunlight
- Sufficient ventilation
- Room temperature is above 0°C
- Keep far away from the heat sources such as coal or gas burning appliances.

Unpacking the washing machine

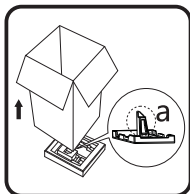

Warning!

- Packaging material (e.g. Films, Styrofoam) can be dangerous for children.
- There is a risk of suffocation! Keep all packaging well away from children.

1. Remove the cardboard box and styrofoam packing.
2. Lift the washing machine and remove the base packaging. Make sure the small triangle foam (a) is removed with the bottom packaging together. If not, lay the unit down on the side surface and remove it manually.

3. Remove the tape securing the power supply cord and drain hose.
4. Remove the inlet hose from the drum.

Remove transport bolts



Warning!

- You must remove the transport bolts from the backside before using the product.

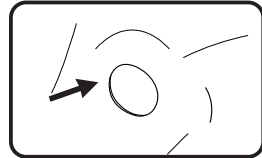
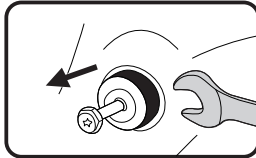
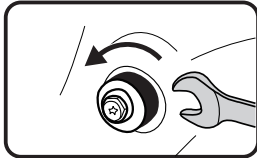

1. Loosen the 4 transport bolts with a spanner.
2. Remove the bolts including the rubber parts and keep them for future use.
3. Close the holes using the cover caps.

Levelling the washing machine



Warning!

- The lock nuts on all four feet must be screwed tightly against the housing.

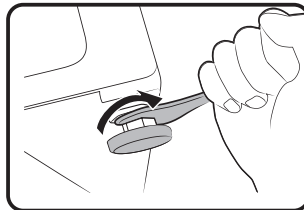

1. Loosen the lock nut.
2. Turn the foot until it reaches the floor.
3. Adjust the legs and lock the nuts with a spanner. Make sure the machine is level and steady.

Connect the water supply hose



Warning!

To prevent leakage or water damage, follow the instructions in this chapter.

- Do not kink, crush or modify water inlet hose.

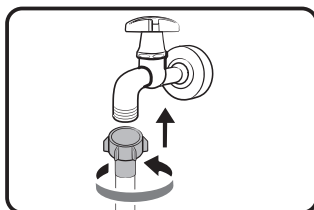
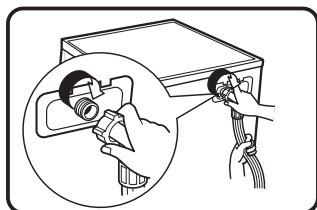

Connect the water supply hose to the water inlet valve and a water tap with cold water as indicated.



Note:

- Connect manually, do not use tools. Check if the connections are tight.

Drain Hose



Warning!

- Do not kink or protract the drain hose.
- Position drain hose properly, otherwise damage might result of water leakage.

There are two ways to place the end of drain hose:

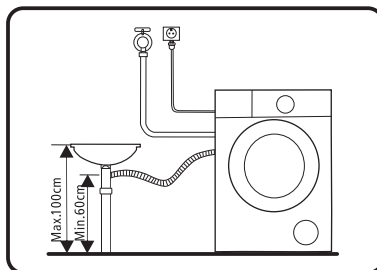
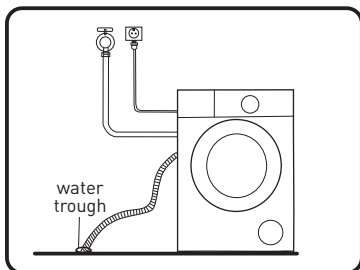

1. Put it into the water trough.
2. Connect it to the branch drain pipe of the trough.

Acoustic Sponge / Panel



Note:

- Please make sure to assemble the acoustic sponges/panel, which can effectively reduce the noise caused by the machine while working, in order to provide you with a more peaceful and quiet living environment.

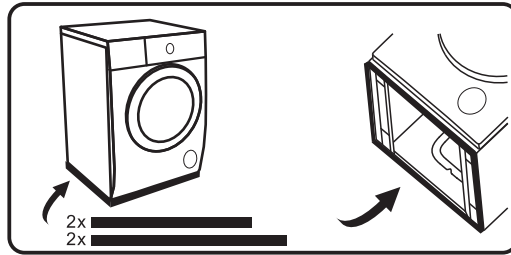

1. Get the machine laid on the floor, using some soft material like foam or clothes between the machine and floor for a protection;
2. Stick the 2x longer sponges to the longer bottom edges of machine, and the 2x shorter sponges to the shorter bottom edges.

Operation

Quick Start



Caution!

- Before washing, please make sure the washer is installed properly.
- Your appliance was thoroughly checked before it left the factory. To remove any residual water and to neutralize potential odors, it's recommended to clean your appliance before first use. For this reason, recommended to clean the inner drum by running the "DRUM CLEAN" or other program with the optional temperature of 90°C. Be careful not to put laundry and detergent in the machine.



Calibration

- It's recommended to calibrate the machine, so that provide the best performance. The appliance is able to detect the amount of laundry loaded. This function is optimizing the product performance by minimizing energy and water consumption, saving you money and time. For this reason it's recommended to calibrate the appliance for best use.
1. Remove all accessories from the drum and close the door;
 2. Insert the mains plug to the socket;
 3. Switch on the machine and within 10 seconds, press "Delay" and "Extra Rinse" simultaneously (normally 3 seconds) until "t19" is displayed;
 4. Press [▷||] to start the appliance and wait till "*****" is displayed, and then "***" [such as "126"] is displayed to indicate the real time drum speed. If the machine is successfully calibrated, "PAS" will be displayed, otherwise, "FAL" will be displayed.

• Before Washing

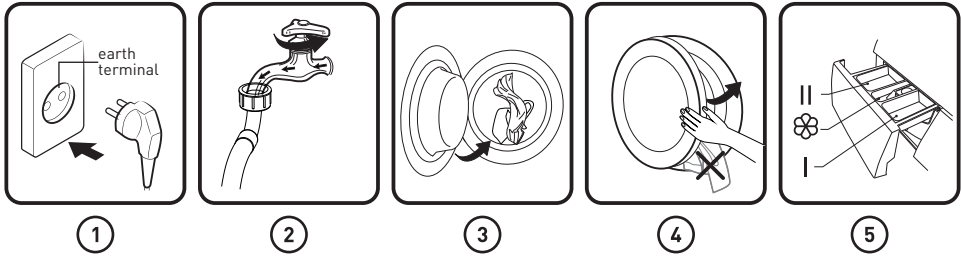

1. Plug in
2. Open tap
3. Load
4. Close door
5. Add detergent



Note:

- Detergent need to be added in compartment I if the pre-wash function is selected.
- When closing the door, please make sure that your clothes are not caught between the sealing ring and the machine door to prevent water leakage caused by pulling and damaging the sealing ring during operation.

• Washing

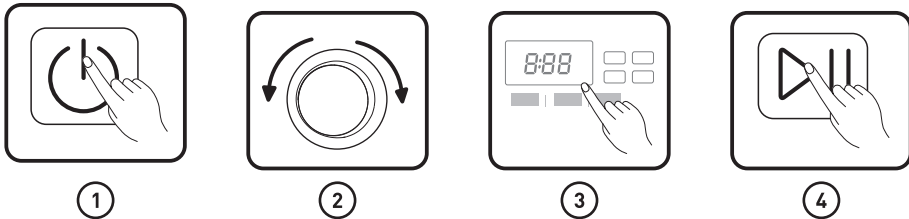

1. Power on
2. Select programme
3. Select function or remain default settings
4. Press Start/Pause to start the program

• After Washing

Buzzer beep and "End" on display.

Before Each Washing

- The ambient temperature of the washing machine should be 5-40°C. If used under 0°C, the inlet valve and draining system may be damaged. If the machine is installed under freezing conditions, it should be transferred to normal ambient temperature to ensure the water supply hose and drain hose can unfreeze before use.

- Please check your laundry care labels and the detergent use instructions before wash. Use non-foaming or less-foaming detergent suitable for machine washing properly.

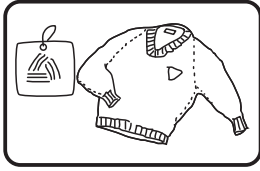

①

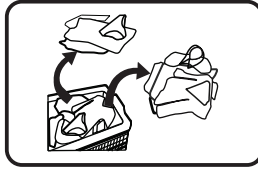

②

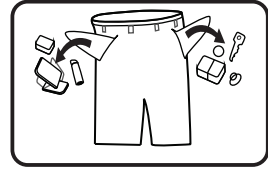

③

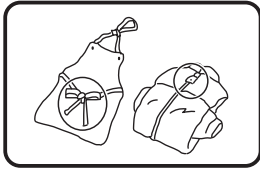

④

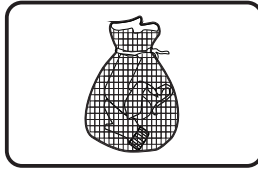

⑤

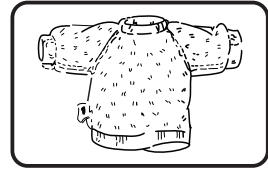

⑥

1. Check the care label
2. Sort laundry according to color and textile type
3. Take all items out of the pockets
4. Tie together long textile strips and belts, close zips and button
5. Put small items into a laundry bag
6. Turn easy-pilling and long-pile fabric inside out

**Warning!**

- Do not wash articles that have been cleaned in, washed in, soaked in, or dabbed with combustible or explosive substances like wax, oil, paint, gasoline, alcohol, kerosene, and other flammable materials.
- Washing single clothes items may easily create big eccentricity and cause alarm due to unbalance. Therefore it is suggested to add one or two more laundry items to the wash so that spin can be done smoothly.
- Do not wash, spin water-proof seats, mats, or clothing.

Detergent Dispenser

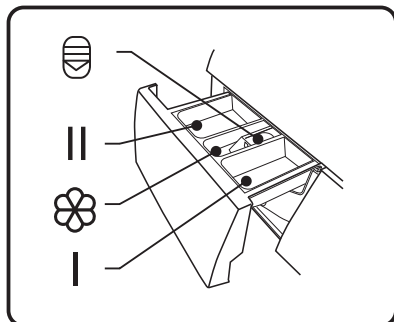

- I Pre wash

- II Main wash

- Softener

- Release button to pull out the dispenser

**Caution!**

- Detergent only need to be added in “compartment I” after selecting pre-wash function.

Control Panel

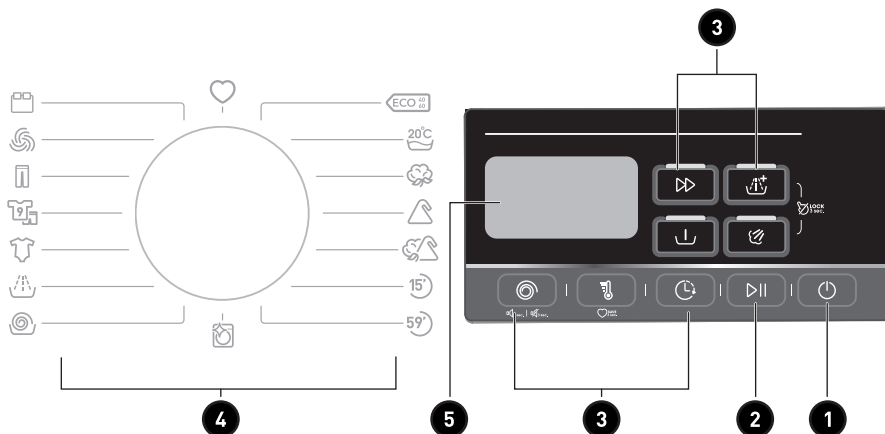

1 On/Off Turn the appliance on and off.

2 Pause/Start Start or pause your programme.

- | | |
|----------------------------|--|
| 3 Option | This allows you to select additional functions. |
| 4 Programmes | Available according to the laundry type. |
| 5 Display | The display shows settings, estimated remaining time, options and status messages. |

Display

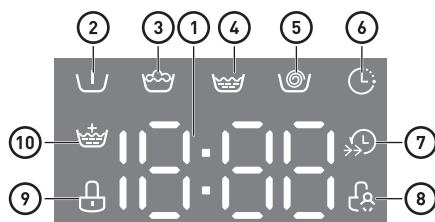

- | | |
|-------------------------|------|
| 1 Display | |
| • Wash Time | 1:25 |
| • Delay Time | 2H |
| • Speed | 400 |
| • Error | E30 |
| • End | End |
| • Temp. | 20 |

2 Pre Wash

3 Wash

4 Rinse

5 Spin

















6 Delay

7 Speed Wash

8 Child Lock

9 Door Lock

10 Extra Rinse

Programme	I	II	
 ECO 40-60		●	○
 20°C Care+		●	○
 Cotton	○	●	○
 Synthetic	○	●	○
 Mix	○	●	○
 Quick 15'		●	○
 Rapid 59'		●	○
 Drum Clean			
 Spin Only			
 Rinse & Spin			○
 Baby Care	○	●	○
 Sports	○	●	○
 Jeans	○	●	○
 Wool		●	○
 Duvet		●	○

● Mandatory ○ Optional

Detergent Recommendation

Recommended washing detergent	Wash cycles	Washing temp.	Type of laundry and textile
Heavy-duty detergent with bleaching agents and optical brighteners	Cotton	40/60	White laundry made from boil-proof cotton or linen
Colour detergent without bleaching agent and optical brighteners	Cotton	20/40	Coloured laundry made from cotton or linen
Color or mild detergent without optical brighteners	Cotton, Synthetic	20/40	Coloured laundry made from easy care fibres or synthetic materials
Mild washing detergent	Synthetic	20	Delicate textiles, silk, viscose
Special wool detergent	Wool	20/40	Wool

**Note:**

- Agglomerating or ropy detergent or additive can be diluted in some water before pouring it into the detergent dispenser, to avoid its inlet to get blocked and thus cause a water overflow.
- Please choose the suitable type of detergent to get a maximum of washing performance and a minimum of water and energy consumption
- To achieve the best cleaning result a proper detergent dosing is important.
- Use a reduced detergent amount if the drum is not filled completely.
- Always adjust the amount of detergent to the water hardness, if your tap water is soft, use less detergent.
- Dose according to how dirty your laundry is, less dirty clothes require less detergent.
- Highly concentrated (compact detergent) requires particularly accurate dosing.

Following symptoms are a sign of detergent overdosing:

- heavy foam formation
- poor washing and rinsing result



Following symptoms are a sign of detergent underdosing:

- laundry turns grey
- built-up of limescale deposits on the drum, the heating element and/or the laundry

Programmes

Model: 10003288 - WF 612 C W566C2







Programme	Load (kg)	Display Time
	6.0	6.0
ECO 40-60	6.0	3:18
20°C Care+	3.0	1:08
Cotton	6.0	3:39
Synthetic	3.0	3:18
Mix	6.0	1:20
Quick 15'	2.0	0:15
Rapid 59'	2.0	0:59
Drum Clean	--	1:18
Spin Only	6.0	0:12
Rinse & Spin	6.0	0:20
Baby Care	6.0	2:01
Sports	3.0	0:47

	Jeans	6.0	1:35
	Wool	2.0	1:07
	Duvet	2.5	1:27

**Note:**

- The parameters in this table are only for user's reference. The actual parameters maybe different with the parameters in above mentioned table.

WF 612 C W566C2

Cycle	Nominal capacity in kg	Temperature setting	Cycle duration in hours and minutes	Energy consumption in kWh/operalling cycle	Water consumption in liter/operalling cycle	Highest temperature °C ⁽¹⁾	Residual moisture in %/ spin speed in rpm ⁽²⁾
	6.0	--	3:18	0.781	51.0	38	62.9%/1150
 ECO	3.0	--	2:36	0.450	40.0	31	62.9%/1150
ECO 40-60 ⁽³⁾	2.0	--	2:36	0.261	31.0	27	62.9%/1150
 20°C Care+	3.0	20	1:08	0.189	41	20	65%/1000
 Cotton	6.0	60	3:44	1.392	65	60	60%/1200
 Mix	6.0	40	1:20	0.696	65	40	65%/1000
 Quick 15'	2.0	Cold	0:15	0.030	31	Cold	70%/800
 Baby Care	6.0	60	2:01	1.212	65	60	65%/1000

- The above data is for reference only, and the data may change due to different actual use conditions.
- The values given for programmes other than the ECO 40-60 programme are indicative only.
- 20°C is able to clean lightly soiled cotton laundry, at a nominal temperature of 20 °C, which complies with the regulation (EU) 2019/2023.
- Compliant to EN 60456:2016/prA2019 With (EU)2019/2014, (EU)2019/2023, (EU)2021/340,(EU)2021/341
The EU energy efficiency class is: C
Energy test program: ECO 40-60. Other as the default.
Half load for 6.0kg machine: 3.0kg.
Quarter load for 6.0kg machine: 2.0kg.

- ¹⁾ The highest temperature reached by the laundry in the wash cycle for at least 5 minutes.
- ²⁾ Residual moisture after the wash cycle in water content percent and the spin speed at which this was achieved.
- ³⁾ The ECO 40-60 programme is able to clean normally soiled cotton laundry declared to be washable at 40°C or 60°C, together in the same cycle. This programme is used to assess the compliance with the regulation (EU) 2019/2023.

The most efficient programmes in terms of energy consumption are generally those that perform at lower temperatures and longer duration.

Loading the household washing machine up to the capacity indicated for the respective programmes will contribute to energy and water savings.

Noise and remaining moisture content are influenced by the spinning speed: the higher the spinning speed in the spinning phase, the higher the noise and the lower the remaining moisture content.

















Caution!

- If there is any break in the power supply while the machine is operating, a special memory stores the selected programme. The machine will continue the programme when the power supply is re-established.

Programmes

Programmes are available according to the laundry type.

























Programmes		
	ECO 40-60	Able to clean normally soiled cotton laundry declared to be washable at 40°C or 60°C, together in the same cycle.
	20°C Care+	Able to clean lightly soiled cotton laundry, at a nominal temperature of 20°C.
	Cotton	Hard-wearing textiles, heat-resistant textiles made of cotton or linen.
	Synthetic	Wash synthetic articles, for example: shirts, coats, blending. While washing the knitting textiles, detergent quantity shall be reduced due to its loose string construction and easily forming bubbles.
	Mix	Mixed load consisting of textiles made of cotton and synthetics.
	Quick 15'	Extra short programme approx, suitable for lightly soiled washing as a small amounts of laundry.
	Rapid 59'	Washing few and not very dirty clothes quickly.



















	Drum Clean	Specially set in this machine to clean the drum and tube. It applies 90°C high temperature sterilization to make the clothes washing more green. When this programme is performed, the clothes or other washing cannot be added. When proper amount of chlorine bleaching agent is put in, the barrel cleaning effect will be better. The customer can use this programme regularly according to the need.
	Spin Only	Spins and drains the water.
	Rinse & Spin	Rinses and then spins the laundry, and then drains the water.
	Baby Care	Washing the baby's clothes, it can make the baby's wear cleaner and make the rinse performance better to protect the baby skin.
	Sports	Washing the activewear.
	Jeans	Specially for jeans.
	Wool	Hand or machine-washable wool or richwool textiles. Especially gentle wash programme to prevent shrinkage, longer programme pauses (textiles rest in wash liquor).
	Duvet	This program is specially designed for washing duvet coats.

**Note:**

- Reference to your product to select the programmes.

Option

	Cycle	Default Temp. (°C)	Default spin speed in rpm	Additional functions
	ECO 40-60	--	--	
	20°C Care+	20	1000	 
	Cotton	40	1200	    
	Synthetic	40	1200	   
	Mix	40	1000	    
	Quick 15'	--	800	 

	Rapid 59'	30	1000	
	Drum Clean	90	--	
	Spin Only	--	1000	
	Rinse & Spin	--	1000	
	Baby Care	60	1000	
	Sports	20	800	
	Jeans	30	800	
	Wool	40	600	
	Duvet	40	800	

**Note:**

- For the maximum spin speed, program time, and other details of the ECO 40-60 program, please refer to the content on the Product Fiche page.
- The table shows which cycle offers which options for adjustment.

**Spin**

When needed, the spinning speed can be adjusted pressing the [Spin] button in the following steps: 1200: 0-600-800-1000-1200

**Delay**

1. Select a programme
2. Press the Delay button to choose the delaying time 0-24H
3. Press [Start/Pause] to start the delay operation



Choose the
Programme

Setting time

Start

To cancel the Delay function, press the "Delay" button before starting the program until the display shows 0 H. If the program has already started, switch the appliance off and afterwards on and select a new programme.



Pre Wash

Extra washing function before the main washing cycle starts to increase the washing performance.



Note: Detergent needs to be added to the compartment I.



Extra Rinse

The laundry will undergo an extra rinse after selecting this function.



Temp.

When needed, the washing temperature can be adjusted by pressing the [Temp.] button in the following steps: Cold - 20°C - 30°C - 40°C - 60°C - 90°C.



Steam

Steam is applicable for daily laundries. The steam can deeply penetrate the fiber, which effectively eliminate bacterias and germs, preventing odors and protecting your health.



Speed Wash

The function can decrease the washing time.



My Cycle

To memory the frequently used programme. After choosing the programme and setting the options, press [Temp.] button for 3 sec. before start to wash. The default setting course is Cotton.



Child Lock

This function is meant to keep children from misusing the controls.



}
} }
}

Press [Extra Rinse] and [Steam] simultaneously for 3 sec until the buzzer beep. The child lock indicator switches on.



Caution!

- When the Child Lock is activated, the display will alternately show "CL" and the remaining time.
- Pressing any other button will cause the Child Lock indicator to flash. When the program ends, "CL" and "End" will alternate on the display.
- The Child Lock deactivates the function of all buttons except the Child lock button! Only the simultaneous pressing of the two buttons can deactivate the Child Lock! Please deactivate the Child Lock before selecting a new program!

**Mute the buzzer**

Choose the
Programme



Press the [Spin] button for 3sec.,
the buzzer is mute.

To act the buzzer function, press the button again for 3 seconds. The setting will be kept until the next reset.

**Caution!**

After Muting the buzzer function, the sounds will not be activated any more.

**Note:**

Usage counter

1. Please press "Speed Wash" and "Delay" on control panel simultaneously and continuously for around 5sec. Under power-on status, and then press "Speed Wash" twice after hearing a valid tone, the device display shows digits--the value can indicate the times of equipment usage.
2. Press "Speed Wash" and "Delay" on control panel simultaneously and continuously for around 5sec, and customer can resume to normal operation.

Cleaning and maintenance



Warning!

- Always unplug the appliance and close the water tap before cleaning and maintenance.

Cleaning the Cabinet

Proper maintenance on the washing machine can extend its working life. The surface can be cleaned with diluted non-abrasive neutral detergents when necessary. If there is any water overflow, use a cloth to wipe it off immediately. Never use sharp items to clean the appliance.



Caution!

- Never use abrasive or caustic agents, formic acids or its diluted solvents or similar substances, like alcohol or chemical products.

Cleaning the Drum

Any rust stains left inside the drum by metal articles must be removed immediately using chlorine-free detergents. Never use steel wool for cleaning the drum!



Note:

- Keep any laundry away from the machine while cleaning the drum.

Cleaning the Door Seal and Glass

Wipe the glass and seal after each wash to remove lint and stains. If lint builds up it can cause leakages.

Remove any coins, buttons and other objects from the seal after each wash.

Clean the Door Seal and Glass every month to ensure the normal operation of the appliance.

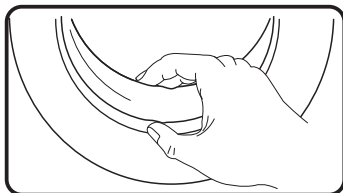

Cleaning the Inlet Filter



Note:

- Diminishing water flow is a sign that the filter need to be cleaned.

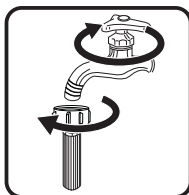

①

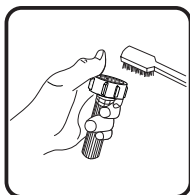

②



③

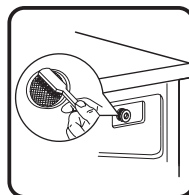

④

1. Close the tap and remove the water supply hose from it.
2. Clean the filter with a brush.
3. Unscrew the water supply hose from the backside of the machine. Pull out the filter with long nose pliers.
4. Use a brush to clean the filter.
5. Reinstall the filter to the water inlet and reconnect the water supply hose.
6. Clean the Inlet filter every 3 months to ensure the normal operation of the appliance.

Clean The Detergent Dispenser

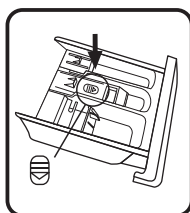

①

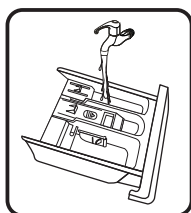

②

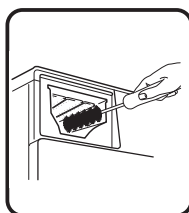

③

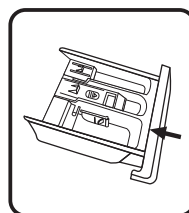

④

1. Press down the release [] on the softener cover and pull the dispenser drawer out of the recess.
2. Lift the softener cover off the dispenser drawer and wash both items with water.
3. Clean the inside of the recess with a brush.
4. Restore the softener cover and push the drawer back into the recess.



Note:

- Do not use abrasive or caustic agents to clean plastic parts.
- Clean the detergent dispenser every 3 months to ensure the normal operation of the appliance.

Cleaning the Drain Pump Filter



Warning!

- Make sure that the machine has finished the washing cycle and is empty. Switch it off and unplug it before cleaning the drain pump filter.
- Be careful of hot water. Allow the water to cool down. Risk of scalding!
- Clean the filter periodically every 3 months to ensure the normal operation of the appliance.

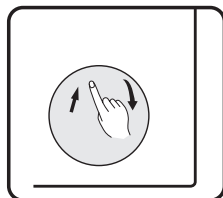

①

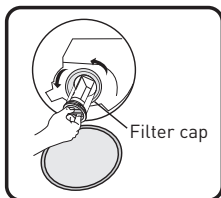

②

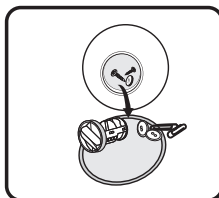

③

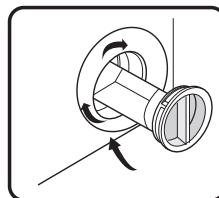

④

1. Open the lower cover cap.
2. Open the filter by turning to the counter clockwise.
3. Remove extraneous matter.
4. Close the lower cover cap.



Caution!

- When the appliance is in use and depending on the programme selected there can be hot water in the pump. Never remove the pump cover during a wash cycle, always wait until the appliance has finished the cycle, and is empty. When replacing the cover, ensure it is securely re-tightened.

Trouble Shooting

Whenever there is a problem with the appliance, check if you can solve it following the tables below. If the problem persists, please contact the customer service.

Description	Possible cause	Solution
Appliance does not start	<ul style="list-style-type: none"> • Door is not closed properly. • Clothes are stuck. 	<ul style="list-style-type: none"> • Close the door properly and restart. • Check the laundry.
Door can't be opened	<ul style="list-style-type: none"> • Safety protection is activated. 	<ul style="list-style-type: none"> • Disconnect the power and restart.
Water leakage	<ul style="list-style-type: none"> • Connections are not tight enough. 	<ul style="list-style-type: none"> • Check and fasten the water inlet pipe. • Check and clean the outlet hose.
Detergent residues in the detergent dispenser	<ul style="list-style-type: none"> • Detergent is damp and/or clotted. 	<ul style="list-style-type: none"> • Clean and wipe the detergent dispenser dry.

Description	Possible cause	Solution
Indicator or display does not work	<ul style="list-style-type: none"> PC board or harness have connection problems. 	<ul style="list-style-type: none"> Switch off the power and check if the mains plug is connected properly.
Abnormal noise	<ul style="list-style-type: none"> Fixing bolts still in place. Floor is not solid or level. 	<ul style="list-style-type: none"> Check if the fixing bolts have been removed. Make sure the appliance is installed on a solid and level floor.
Error Codes		
E30	<ul style="list-style-type: none"> Door is not closed properly 	<ul style="list-style-type: none"> Close the door properly and restart.
E10	<ul style="list-style-type: none"> Water injecting problem during wash cycle. 	<ul style="list-style-type: none"> Check if the water pressure is high enough. Straighten the water pipe. Clean the inlet valve filter.
E21	<ul style="list-style-type: none"> Overtime water draining 	<ul style="list-style-type: none"> Check the drain hose for blockage.
E12	<ul style="list-style-type: none"> Water overflow 	<ul style="list-style-type: none"> Restart the appliance.
EXX	<ul style="list-style-type: none"> Others 	<ul style="list-style-type: none"> Restart the appliance. If problem persists, please contact the customer service.



Warning!

Risk of electric shock

- Never try repair an appliance which is defective or presumed to be defective. You may put your own and future users' lives in danger. Only authorised specialists are allowed to carry out this repair work.
- Improper repair will void the warranty and subsequent damages can't be recognized!

Transport

IMPORTANT STEPS WHEN MOVING THE APPLIANCE

- Unplug the appliance and close the water inlet tap.
- Check, if the door and the detergent dispenser are closed properly.

- Remove the water inlet pipe and the outlet hose from the house installations.
- Let the water drain completely from the appliance (see "Maintenance Cleaning the drain pump filter").
- Important: Re-install the 4 transport bolts in the back of the appliance.
- This appliance is heavy. Transport with care. Never hold any protruding part of the machine when lifting. The machine door cannot be used as a handle.

Product Fiche

Supplier's name or trade mark^{(a),(c)}:

Supplier's address^{(a),(c)}:

Model identifier^(a): WF 612 C W566C2

General product parameters:

Parameter	Value		Parameter	Value
Rated capacity ^(b) (kg)	6.0		Dimensions in cm ^{(a),(c)}	Height 85
				Width 60
				Depth 40
Energy efficiency index ^(b) (EEI _w)	68.4		Energy efficiency class ^(b)	C ^(d)
Washing efficiency index ^(b)	1.031		Rinsing effectiveness (g/kg) ^(b)	5.0
Energy consumption in kWh per cycle, based on the eco 40-60 programme. Actual energy consumption will depend on how the appliance is used.	0.554		Water consumption in litre per cycle, based on the eco 40-60 programme. Actual water consumption will depend on how the appliance is used and on the hardness of the water.	43
Maximum temperature inside the treated textile ^(b) (°C)	Rated capacity	38	Weighted remaining moisture content ^(b) (%)	62.9
	Half	31		
	Quarter	27		
Spin speed ^(b) (rpm)	Rated capacity	1150	Spin-drying efficiency class ^(b)	C ^(d)
	Half	1150		
	Quarter	1150		
Programme duration ^(b) (h:min)	Rated capacity	3:18	Type	free-standing
	Half	2:36		
	Quarter	2:36		

Product Fiche

Airborne acoustical noise emissions in the spinning phase ^(a) (dB(A) re 1 pW)	76	Airborne acoustical noise emission class ^(b) (spinning phase)	B ^(d)
Off-mode (W) (if applicable)	0.50	Standby mode (W) (if applicable)	N/A
Delay start (W) (if applicable)	4.00	Networked standby (W) (if applicable)	N/A
Minimum duration of the guarantee offered by the supplier^{(a),(c)}:			
This product has been designed to release silver ions during the washing cycle		NO	

Additional information:

Weblink to the supplier's website, where the information in point 9 of Annex II to Commission Regulation (EU) 2019/2023 (1) is found:

^(a) this item shall not be considered relevant for the purposes of Article 2(6) of Regulation (EU) 2017/1369.

^(b) for the eco 40-60 programme.

^(c) changes to this item shall not be considered relevant for the purposes of paragraph 4 of Article 4 of Regulation (EU) 2017/1369.

^(d) if the product database automatically generates the definitive content of this cell, the supplier shall not enter these data.

¹⁾ The actual energy consumption will depend on how the appliance is used.

²⁾ The actual water consumption will depend on how the appliance is used and on the hardness of the water.

³⁾ Delivery of the spare parts within 15 working days after having received the order.

Product Data Sheet concerning (EU) 2019/2014

The product data sheet for your appliance can be found online.

Go to <https://eprel.ec.europa.eu> and enter the model identifier for your appliance to download the data sheet.

The model identifier for your appliance can be found in the technical specifications section.

Merci !

Merci d'avoir choisi ce produit VALBERG.
Choisis, testés et recommandés par ELECTRO DEPOT,
les produits de la marque VALBERG vous assurent
une utilisation simple, une performance fiable et
une qualité irréprochable.
Grâce à cet appareil, vous savez que chaque utilisation
vous apportera satisfaction.

Bienvenue chez ELECTRO DEPOT.

Visitez notre site Internet : www.electrodepot.fr
www.electrodepot.be

VOTRE AVIS COMPTE !



**PARTAGEZ
VOTRE EXPERIENCE
SUR LES PRODUITS**

Parce que votre satisfaction est notre priorité, nous vous proposons
de donner votre avis sur ce produit. Il sera transmis et analysé par
nos équipes afin d'améliorer continuellement le produit.

Donnez votre avis sur <http://www.electrodepot.fr/avis-client>



ELECTRO DEPOT

30

FR

Table des matières

A

Aperçu de l'appareil

Pièces
Spécifications

B

**Utilisation de
l'appareil**

Installation
Fonctionnement

C

**Nettoyage et
entretien**

Nettoyage et entretien
Dépannage
Transport

Fiche produit

Les notices sont aussi disponibles sur le site
<http://www.electrodepot.fr/sav/notices/>
<http://www.electrodepot.be/fr/sav/notices>

Pièces

A Couvercle supérieur**B** Panneau de commande**C** Cordon d'alimentation**D** Tambour**E** Tuyau de vidange**F** Clapet pour réparation**G** Porte**H** Bac à lessive**I** Tuyau d'arrivée d'eau**J** 4 couvercles**K** 1 tuyau d'arrivée d'eau froide**L** Mousse acoustique**Remarque :**

- L'image du produit est fournie à titre d'illustration uniquement. Veuillez vous reporter au produit réel pour référence.

Spécifications

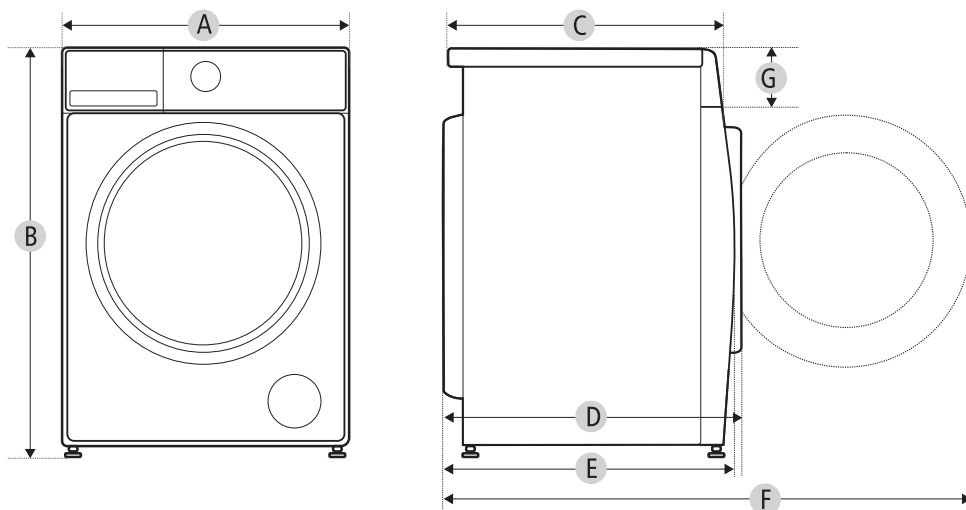

Modèle : 10003288 - WF 612 C W566C2

Alimentation électrique : 220-240 V~, 50 Hz

MAX. Courant : 10 A

Pression d'eau standard : 0,05 MPa~1 MPa

Capacité de lavage : 6,0 kg

Dimensions

A : 595 mm

B : 850 mm

C : 400 mm

Poids : 55 kg

Puissance nominale : 1 950 W

Dimensions de référence

D : 463 mm

E : 421 mm

C : 897 mm

G : 152 mm

Installation

Zone d'installation

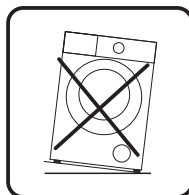
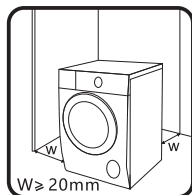

Avertissement !

- Il est important que le produit soit stable, car cela l'empêchera de se déplacer ! Assurez-vous que la machine soit debout, droite et stable.
- Veillez à ce que le produit ne soit pas placé sur son cordon d'alimentation.
- Assurez-vous de respecter les distances minimales entre le produit et les murs, telles qu'indiquées sur l'image.

Avant d'installer la machine, sélectionnez un emplacement conforme aux exigences suivantes :

- À la surface ferme, sèche et plane.
- Non exposé à la lumière directe du soleil.
- Ventilation adéquate
- Avec une température ambiante supérieure à 0 °C.
- Éloigné de sources de chaleur telles que des appareils à combustion fonctionnant au gaz ou au charbon.

Déballage du lave-linge

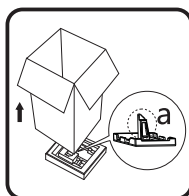

Avertissement !

- Les matériaux d'emballage (par ex. : films protecteurs, polystyrène) peuvent représenter un danger pour les enfants.
- Il existe un risque d'étouffement ! Veillez à ce que tous les éléments d'emballage restent hors de portée des enfants.

1. Retirez le carton d'emballage et les éléments en polystyrène.
2. Soulevez le lave-linge et retirez l'emballage de la base. Veillez à ce que le petit triangle en mousse (a) soit retiré avec l'emballage de la base. Si ce n'est pas le cas, couchez l'appareil sur le côté et retirez-le manuellement.
3. Retirez le ruban adhésif fixant le cordon d'alimentation et le tuyau de vidange.
4. Retirez le tuyau d'arrivée du tambour.

Retirer les vis de transport



Avertissement !

- Vous devez retirer les vis de transport au dos du produit avant de l'utiliser.

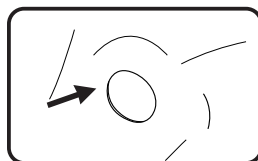
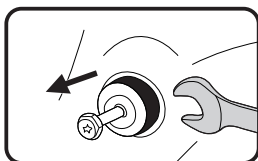
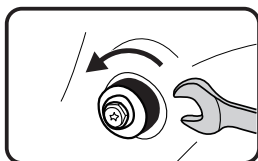

1. Desserrez les 4 vis de transport à l'aide d'une clé.
2. Retirez les vis avec les pièces en caoutchouc et conservez-les pour une utilisation ultérieure.
3. Couvrez les orifices avec les couvercles.

Mise à niveau du lave-linge



Avertissement !

- Les écrous de verrouillage des quatre pieds doivent être serrés fermement contre la paroi.

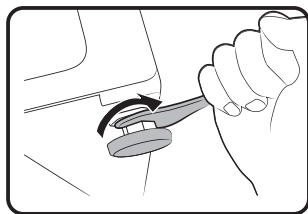

1. Desserrez l'écrou de verrouillage.
2. Faites tourner le pied jusqu'à ce qu'il atteigne le sol.
3. Réglez les pieds et serrez les écrous à l'aide d'une clé. Veillez à ce que la machine soit stable et droite.

Raccord du tuyau d'arrivée d'eau**Avertissement !**

Pour éviter une fuite ou des dégâts des eaux, suivez les instructions de ce chapitre.

- Ne pliez pas, n'écrasez pas et ne modifiez pas le tuyau d'arrivée d'eau.

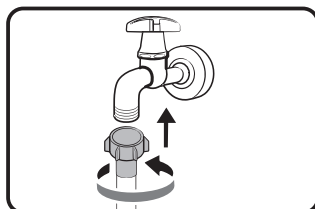
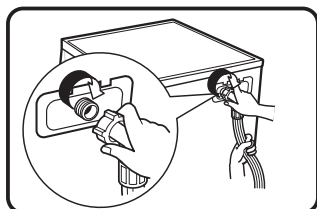

Raccordez le tuyau d'arrivée d'eau à la vanne d'arrivée d'eau et à un robinet d'eau froide comme indiqué.

**Remarque :**

- Le raccordement doit se faire manuellement, sans outils. Vérifiez que les raccords sont étanches.

Tuyau d'évacuation d'eau**Avertissement !**

- Ne pliez pas et ne tirez pas le tuyau de vidange.
- Placez correctement le tuyau de vidange pour éviter des dégâts liés à une fuite d'eau.

Le tuyau de vidange peut être positionné de deux manières différentes :

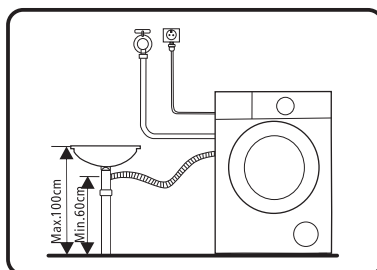
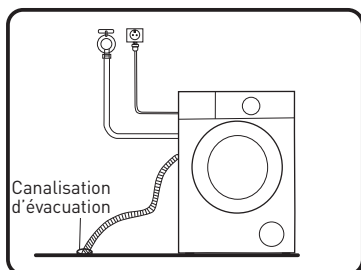

1. Placez-le dans la canalisation d'évacuation des eaux usées.
2. Raccordez-le au tuyau de branchement de la canalisation d'évacuation des eaux usées.

Mousse/Panneau acoustique**Remarque :**

- Veillez à assembler la mousse/le panneau acoustique, qui peuvent réduire de manière efficace le bruit causé par la machine en fonctionnement et ainsi offrir un environnement de vie plus calme et plus paisible.

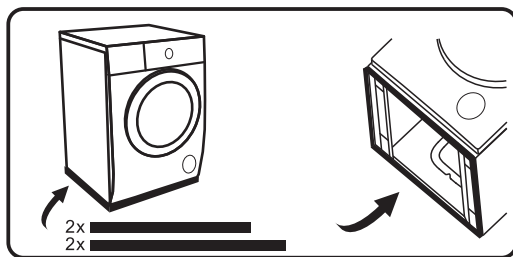

1. Couchez la machine au sol, en la protégeant grâce à un matériau souple posé sur le sol, comme de la mousse ou des vêtements.
2. Collez les 2 bandes de mousse plus longues sur les rebords plus longs de la machine, et les 2 bandes plus courtes sur les rebords plus courts.

Fonctionnement

Démarrage rapide



Attention !

- Avant toute utilisation, assurez-vous que le lave-linge est correctement installé.
- Votre appareil a fait l'objet d'une inspection minutieuse avant son départ de l'usine. Pour éliminer toute eau résiduelle et toute odeur potentielle, il est recommandé de nettoyer l'appareil avant la première utilisation. Il est ainsi conseillé de nettoyer le tambour intérieur en lançant le programme « Nettoyage du tambour » ou tout autre programme pour lequel il est possible de choisir une température de 90 °C. Veillez à ne pas placer de linge ni de lessive dans la machine.



Calibrage

- Il est recommandé de calibrer la machine afin qu'elle offre les meilleures performances. Cet appareil est capable de détecter la quantité de linge chargé. Cette fonction permet d'optimiser les performances du produit en diminuant la consommation d'eau et d'électricité, ce qui vous fait économiser du temps et de l'argent. Il est donc conseillé de calibrer l'appareil pour une utilisation optimale.
 1. Retirez tous les accessoires du tambour et fermez la porte.
 2. Insérez la fiche d'alimentation dans la prise secteur.
 3. Mettez la machine en marche et dans les 10 secondes, appuyez et maintenez enfoncés simultanément les boutons « Temp. » et « Boost » (en général pendant 3 secondes) jusqu'à ce que « t19 » s'affiche.
 4. Appuyez sur [▶] pour démarrer l'appareil et attendez que «****» s'affiche, puis «***» [par exemple "126"] qui indique la vitesse du tambour en temps réel. Si l'appareil est calibré avec succès, « PAS » s'affiche, sinon « FAL » s'affiche.

- **Avant le lavage**

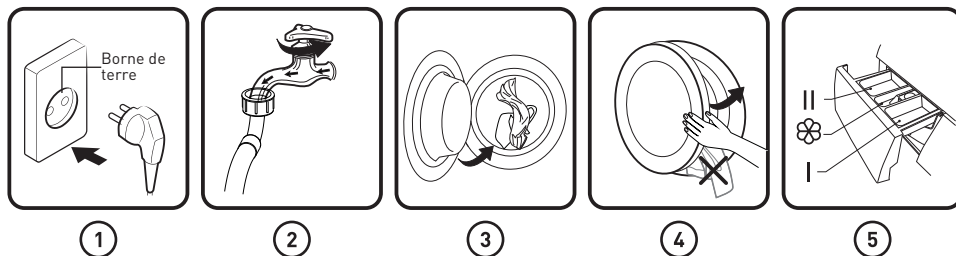

1. Brancher
2. Ouvrir le robinet
3. Charger
4. Fermer la porte
5. Ajouter la lessive



Remarque :

- Il faut ajouter la lessive dans le compartiment I si la fonction de pré-lavage est sélectionnée.
- Lors de la fermeture de la porte, veuillez vous assurer qu'il n'y a pas de vêtements coincés entre le joint d'étanchéité et la porte de l'appareil, afin d'éviter toute fuite causée par un étirement ou des dommages subis par le joint pendant l'utilisation.

- **Lavage**

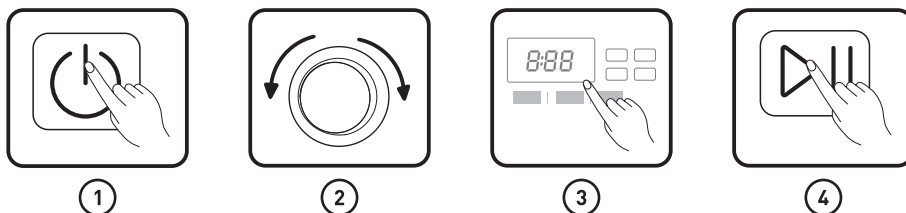

1. Mise en marche
2. Choisir un programme
3. Choisir une fonction ou conserver les réglages par défaut
4. Appuyez sur Démarrer/Pause pour lancer le programme

- **Après le lavage**

La sonnerie retentit et « End » (Fin) s'affiche à l'écran.

Avant chaque lavage

- La température ambiante doit être comprise entre 5 et 40 °C pour utiliser le lave-linge. S'il est utilisé à une température inférieure à 0 °C, la vanne d'arrivée d'eau et le système de vidange pourraient être endommagés. Si la machine est installée dans des conditions glaciales, elle doit être transférée dans un endroit à la température ambiante normale pour que le tuyau d'arrivée d'eau et le tuyau de vidange puisse dégeler avant l'utilisation.
- Veuillez vérifier les étiquettes d'entretien de votre linge et les consignes d'utilisation de votre lessive avant de commencer un lavage. Utilisez des lessives non moussantes ou peu moussantes adaptées aux lave-linge de façon correcte.

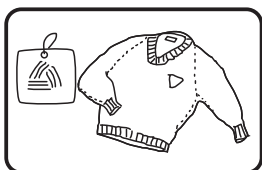

①

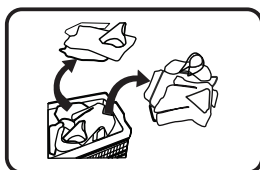

②

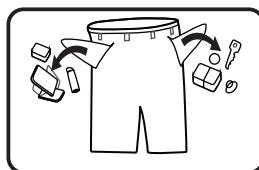

③

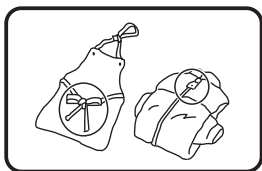

④

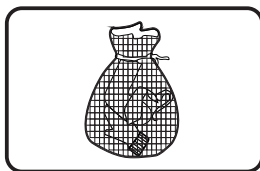

⑤

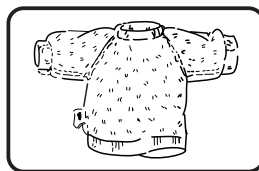

⑥

1. Vérifier l'étiquette d'entretien
2. Trier le linge en fonction des couleurs et du type de textile
3. Retirer tous les objets des poches
4. Nouer les longues bandes de textile et les ceintures, fermer les fermetures éclair et les boutons
5. Placer les petits articles dans un sac à linge
6. Placer les articles s'em mêlant facilement et les tissus à longs poils à l'envers

**Avertissement !**

- Ne lavez pas d'articles ayant été nettoyés, lavés, trempés dans des substances combustibles ou explosives comme de la cire, du pétrole, de la peinture, de l'essence, de l'alcool ou du kérosène et d'autres matériaux inflammables, ou qui en ont été aspergés.
- Laver un seul article peut facilement créer un déséquilibre important dans le tambour et causer le déclenchement d'une alerte. Il est donc conseillé d'ajouter un ou deux articles supplémentaires pour les laver ensemble, afin de permettre un essorage fluide.
- Ne lavez pas et n'essorez pas de housses de siège, tapis ou vêtements imperméables à l'eau.

Distributeur de détergent

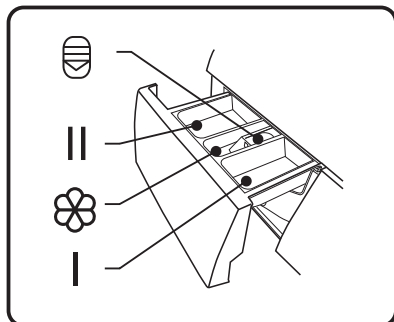

- I Prélavage

- II Lavage principal

- 🌸 Adoucissant

- 🔒 Bouton de déblocage permettant de retirer le bac

**Attention !**

- Il ne faut ajouter de lessive dans le « compartiment I » qu'après avoir sélectionné la fonction de prélavage.

Panneau de commande

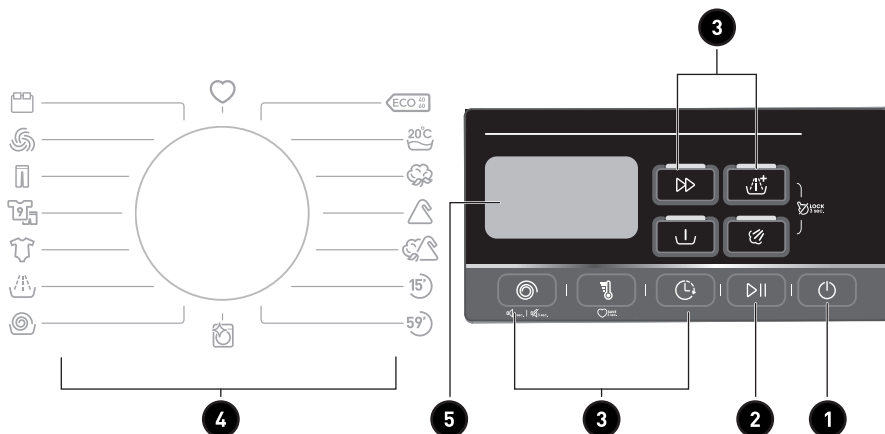

1 Marche/Arrêt Pour mettre l'appareil en marche et hors tension.







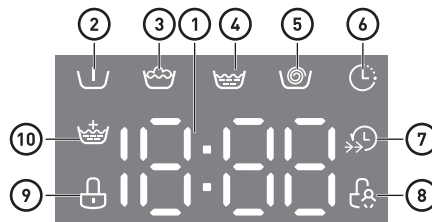









2 Démarrer/Pause Pour démarrer le programme ou le mettre en pause.

3 Options	Cette touche vous permet de sélectionner une fonction supplémentaire.
4 Programmes	Programmes disponibles à la sélection selon le type de linge.
5 Affichage	L'écran affiche les réglages, une estimation du temps restant, les options et les messages d'état.

Affichage



1 Affichage	
• Temps de lavage	1:25
• Départ différé	2H
• Vitesse	400
• Erreur	E30
• Fin	End
• Temp.	20
2 Prélavage	
3 Lavage	
4 Rinçage	
5 Essorage	
6 Départ différé	
7 Lavage express	
8 Sécurité enfant	
9 Verrou de porte	
10 Rinçage Plus	

Programme	I	II	
 ÉCO 40-60		●	○
 20°C Soins+		●	○
 Coton	○	●	○
 Synthétiques	○	●	○
 Mixte	○	●	○
 Rapide 15'		●	○
 Rapide 59'		●	○
 Nettoyage du tambour			
 Essorage Seul			
 Rinçage et essorage			○
 Bébé	○	●	○
 Sports	○	●	○
 Jean	○	●	○
 Laine		●	○
 Duvet		●	○

● Obligatoire ○ Optionnel

Recommandations en matière de lessive

Lessive recommandée	Programmes de lavage	Temp. de lavage	Type de linge et textile
Lessive puissante avec agents de blanchiment et azurants optiques	Coton	40/60	Linge blanc composé de coton ou lin résistant aux températures élevées
Lessive pour couleurs sans agents de blanchiment ni azurants optiques	Coton	20/40	Lessive colorée composée de coton ou lin
Lessive pour couleurs ou douce sans azurants optiques	Coton, Synthétique	20/40	Lessive colorée composée de fibres à entretien facile ou de matériaux synthétiques

Lessive douce	Synthétiques	20	Textiles délicats, soie, viscosse
Lessive spéciale laine	Laine	20/40	Laine

**Remarque :**

- La lessive ou les additifs agglomérants ou fibreux peuvent être dilués dans de l'eau avant d'être versés dans le bac à lessive, afin d'éviter qu'il ne se bloque et n'entraîne un débordement d'eau.
- Veuillez choisir un type de lessive adapté pour obtenir des performances de lavage maximales avec une consommation d'eau et d'électricité minimale.
- Pour bénéficier de résultats de lavage optimaux, il est important de doser correctement la lessive.
- Utilisez une quantité de lessive réduite si le tambour n'est pas complètement rempli.
- Ajustez toujours la quantité de lessive selon la dureté de l'eau. Si votre eau du robinet est douce, utilisez moins de lessive.
- Choisissez la dose selon le degré de saleté du linge. Des vêtements peu sales nécessitent moins de lessive.
- Les lessives à haute concentration (lessives concentrées) requièrent un dosage particulièrement précis.

Voici les signes d'une quantité de lessive excessive :

- Formation de mousse excessive
- Résultats de lavage et de rinçage médiocres

Voici les signes d'une quantité de lessive insuffisante :

- Linge qui devient gris
- Accumulation de dépôts de calcaire sur le tambour, l'élément chauffant et/ou le linge

Programmes

Modèle : 10003288 - WF 612 C W566C2

	Programme	Charge (kg)	Durée affichée
		6,0	6,0
	ÉCO 40-60	6,0	3:18
	20°C Soin+	3,0	1:08
	Coton	6,0	3:39
	Synthétiques	3,0	3:18
	Mixte	6,0	1:20
	Rapide 15'	2,0	0:15
	Rapide 59'	2,0	0:59

B

Utilisation de l'appareil

	Nettoyage du tambour	--	1:18
	Essorage Seul	6,0	0:12
	Rinçage et essorage	6,0	0:20
	Bébé	6,0	2:01
	Sports	3,0	0:47
	Jean	6,0	1:35
	Laine	2,0	1:07
	Duvet	2,5	1:27



Remarque :

- Les paramètres indiqués dans ce tableau ne sont fournis qu'à titre indicatif. Les réglages réels peuvent différer des paramètres indiqués dans le tableau ci-dessus.

WF 612 C W566C2

Cycle	Capacité nominale en kg	Réglage de la température	Durée du programme en heures et minutes	Consommation électrique en kWh/cycle de fonctionnement	Consommation d'eau en litre/cycle de fonctionnement	Température la plus élevée en °C ⁽¹⁾	Humidité résiduelle en %/vitesse d'essorage en tr/min ⁽²⁾
	6,0	--	3:18	0,781	51,0	38	62,9 % / 1150
ÉCO 40-60 ⁽³⁾	3,0	--	2:36	0,450	40,0	31	62,9 % / 1150
	2,0	--	2:36	0,261	31,0	27	62,9 % / 1150
20°C Soins+	3,0	20	1:08	0,189	41	20	65 % / 1 000
Coton	6,0	60	3:44	1,392	65	60	60 % / 1200
Mixte	6,0	40	1:20	0,696	65	40	65 % / 1 000
Rapide 15'	2,0	Froid	0:15	0,030	31	Froid	70 % / 800
Bébé	6,0	60	2:01	1,212	65	60	65 % / 1 000

- Les données mentionnées ci-dessus sont fournies à titre de référence uniquement et peuvent changer selon les conditions d'utilisation réelles.
- Les données fournies pour les programmes autres que le programme ÉCO 40-60 ne sont données qu'à titre d'indication.
- Le programme à 20 °C permet de laver le linge en coton légèrement sale à une température nominale de 20 °C, conformément au règlement (UE) 2019/2023.
- Concernant les normes EN 60456:2016/prA2019 avec (UE) 2019/2014, (UE) 2019/2023, (UE)2021/340, (UE) 2021/341.

La classe d'efficacité énergétique européenne est : C

Programme pour le test d'énergie : ÉCO 40-60. Autre comme programme par défaut.

Demi-charge pour une machine de 6,0 kg : 3,0 kg.

Quart de charge pour une machine de 6,0 kg : 2,0 kg.

- ¹⁾ La température la plus élevée atteinte par le linge durant le cycle de lavage pendant au moins 5 minutes.
- ²⁾ Humidité résiduelle après le cycle de lavage, en pourcentage de teneur en eau et la vitesse d'essorage à laquelle ce résultat est produit.
- ³⁾ Le programme ÉCO 40-60 est capable de laver du linge en coton normalement sale, pouvant être lavé à 40 °C ou à 60 °C, au cours d'un même cycle. Ce programme est utilisé pour évaluer la conformité au règlement (UE) 2019/2023.

Les programmes les plus efficaces en termes de consommation énergétiques sont généralement ceux qui utilisent des températures plus basses et durent plus longtemps.

Charger un lave-linge domestique jusqu'à la capacité indiquée pour les programmes respectifs contribuera à économiser de l'eau et de l'électricité.

Le bruit et la teneur en humidité restante dépendent de la vitesse d'essorage : plus la vitesse d'essorage est élevée pendant l'essorage, plus le bruit sera élevé et moins il y aura d'humidité restante.

















Attention !

- En cas de coupure de courant pendant l'utilisation de l'appareil, le programme sélectionné reste dans sa mémoire. La machine reprendra le programme une fois le courant rétabli.

Programmes

Les programmes sont disponibles à la sélection selon le type de linge.

Programmes		
	ÉCO 40-60	Pour laver du linge en coton normalement sale, pouvant être lavé à 40 °C ou à 60 °C, au cours d'un même cycle.
	20°C Soin+	Permet de laver le linge en coton légèrement sale à une température nominale de 20 °C.

	Coton	Textiles robustes, textiles résistant à la chaleur composés de coton ou de lin.
	Synthétiques	Pour laver les articles synthétiques, par exemple les chemises, les manteaux et les textiles mélangés. Lors du lavage de textiles tricotés, la quantité de lessive doit être réduite à cause de leur structure moins dense entraînant une formation accrue de mousse.
	Mixte	Charge mixte, comprenant des textiles composés de coton et de fibres synthétiques.
	Rapide 15'	Programme extra court pour une petite quantité de linge peu sale.
	Rapide 59'	Pour laver rapidement des articles peu nombreux et peu sales.
	Nettoyage du tambour	Ce programme applique une stérilisation à haute température de 90°C pour rendre le lavage des vêtements plus écologique. Ce programme ne peut pas être lancé avec des vêtements ou autre type de linge. L'effet nettoyant sera plus efficace dans le tambour si une quantité adaptée d'agent de blanchiment au chlore. L'utilisateur peut utiliser ce programme régulièrement selon ses besoins.
	Essorage Seul	Pour essorer et évacuer l'eau.
	Rinçage et essorage	Pour rincer et essorer le linge, puis évacuer l'eau.
	Bébé	Pour laver les vêtements pour bébé. Il nettoie et rince mieux les vêtements afin de protéger la peau des bébés.
	Sports	Pour laver les vêtements de sport.
	Jean	Spécialement adapté aux jeans.
	Laine	Programme particulièrement doux évitant le rétrécissement des articles. Pauses plus longues pendant le programme (quand les textiles reposent dans l'eau avec la lessive).
	Duvet	Ce programme est spécialement conçu pour le lavage des housses de couette.

B

Utilisation de l'appareil

**Remarque :**

- Reportez-vous à votre appareil pour la sélection des programmes.

Options

	Cycle	Temp. par défaut (°C)	Vitesse d'essorage par défaut (tr/min)	Fonctions supplémentaires
	ÉCO 40-60	--	--	
	20°C Soins+	20	1 000	
	Coton	40	1200	
	Synthétiques	40	1200	
	Mixte	40	1 000	
	Rapide 15'	--	800	
	Rapide 59'	30	1 000	
	Nettoyage du tambour	90	--	
	Essorage Seul	--	1 000	
	Rinçage et essorage	--	1 000	
	Bébé	60	1 000	
	Sports	20	800	
	Jean	30	800	
	Laine	40	600	
	Duvet	40	800	

**Remarque :**

- Pour connaître la vitesse d'essorage maximale, la durée du programme et d'autres détails du programme ÉCO 40-60, veuillez vous reporter au contenu de la page de la fiche produit.
- Le tableau indique les options pouvant être réglées pour chaque programme.



Essorage

Lorsque cela est nécessaire, la vitesse d'essorage peut être réglée en appuyant sur le bouton [Spin]. La séquence est la suivante : 1 200 : 0-600-800-1000-1200



Départ différé

1. Choisissez un programme.
2. Appuyez sur le bouton Départ différé pour sélectionner le délai, de 0 à 24 h.
3. Appuyez sur le bouton [Démarrer/Pause] pour activer le départ différé.



Choisir un
programme



Définir la durée



Démarrer

Pour annuler la fonction Départ différé, appuyez sur la touche « Départ différé » avant de commencer le programme jusqu'à ce que l'écran affiche 0 H. Si le programme a déjà commencé, éteignez l'appareil, puis remettez-le en marche et sélectionnez un nouveau programme.



Pré-lavage

Cette fonction de lavage supplémentaire avant le début du cycle de lavage principal permet d'améliorer les performances de lavage.



Remarque : La lessive doit être ajoutée au compartiment I.



Rinçage Plus

Le linge bénéficie d'un rinçage supplémentaire lorsque cette fonction est sélectionnée.



Temp.

Lorsque cela est nécessaire, la température de lavage peut être réglée en appuyant sur le bouton de température. La séquence est la suivante : Froid - 20 °C - 30 °C - 40 °C - 60 °C - 90 °C.



Vapeur

De la vapeur est ajoutée au lavage du linge quotidien. Cette vapeur pénètre en profondeur dans les fibres, éliminant de façon efficace les germes et les bactéries, ce qui empêche la formation d'odeurs et protège votre santé.



Lavage express

Cette fonction permet de réduire la durée de lavage.

**Mon programme**

Pour mémoriser le programme utilisé le plus souvent. Après avoir choisi le programme et réglé les options, appuyez sur le bouton [Temp] pendant 3 secondes avant de démarrer le lavage. Le programme réglé par défaut est Coton.

**Verrouillage enfant**

Cette fonction est conçue pour empêcher les enfants d'utiliser les commandes.



Appuyez en même temps sur les boutons [Rinçage extra] et [Vapeur] pendant 3 secondes, jusqu'à ce que la sonnerie retentisse. Le voyant du verrouillage enfant s'allume.

**Attention !**

- Lorsque le verrouillage enfant est activé, l'écran affiche en alternance « CL » et le temps restant.
- Si vous appuyez sur un autre bouton, le voyant verrouillage enfant clignotera. À la fin du programme, « CL » et « END » sont affichés en alternance à l'écran.
- Le verrouillage enfant désactive la fonctionnalité de tous les boutons, à l'exception du bouton de verrouillage enfant ! Seule une pression simultanée sur les deux boutons permet de désactiver le verrouillage enfant ! Désactivez le verrouillage enfant avant de sélectionner un nouveau programme !

**Désactivation de la sonnerie**

Choisir un programme

Appuyer sur le bouton [Essorage] pendant 3 secondes pour désactiver la sonnerie.

Pour réactiver la fonction de sonnerie, appuyez à nouveau pendant 3 secondes sur ces boutons. Ce réglage sera conservé jusqu'à la prochaine réinitialisation.

**Attention !**

Une fois la sonnerie désactivée, toutes les alertes sonores de l'appareil sont désactivées.

**Remarque :**

Compteur d'utilisations

1. Pour accéder au compteur d'usage, appuyer simultanément sur les touche «Vitesse» et «Départ différé» du panneau de contrôle pendant 5 secondes après avoir allumé l'appareil. Après avoir entendu un signal sonore de validation, appuyer 2 fois sur la touche «Vitesse». L'appareil affiche alors la quantité de cycle lancés sur l'appareil sous la forme de chiffre.
2. Pour sortir du mode compteur d'usage, appuyez ensuite simultanément sur les bouton «Vitesse» et «Départ différé» pendant 5 seconde. L'appareil repasse alors en fonctionnement normal.

Nettoyage et entretien



Avertissement !

- Débranchez toujours l'appareil et fermez le robinet d'eau avant d'effectuer une opération de nettoyage ou d'entretien.

Nettoyage du corps de l'appareil

L'entretien correct du lave-linge permet de prolonger sa durée de vie. Ses surfaces peuvent être nettoyées avec du détergent neutre non abrasif dilué, si nécessaire. En cas de débordement d'eau, essuyez-la immédiatement avec un chiffon. N'utilisez jamais d'objets pointus pour nettoyer l'appareil.



Attention !

- N'utilisez jamais de produits abrasifs ou caustiques, d'acides formiques ou de solvants dérivés dilués ni de substances similaires, comme de l'alcool ou des produits chimiques.

Nettoyage du tambour

Toute tache de rouille laissée dans le tambour par les articles métalliques doit être enlevée immédiatement à l'aide de détergent non chloré. N'utilisez jamais de paille de fer pour nettoyer le tambour !

**Remarque :**

- Gardez le linge à l'écart de la machine lorsque vous nettoyez le tambour.

Nettoyage du joint de porte et du hublot

Essuyez le hublot et le joint après chaque lavage pour retirer les peluches et les taches. Une accumulation de peluches peut entraîner des fuites.

Retirez pièces, boutons et autres objets du joint après chaque lavage.

Nettoyez le joint de porte et le hublot tous les mois pour garantir le bon fonctionnement de l'appareil.

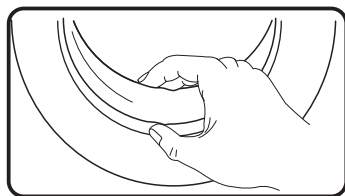
**Nettoyage du filtre d'arrivée****Remarque :**

- Un flux d'eau réduit indique que le filtre doit être nettoyé.

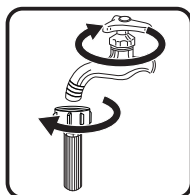

①

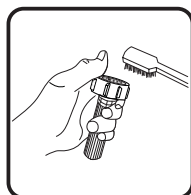

②



③

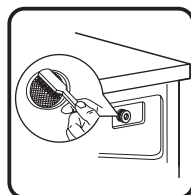

④

1. Fermez le robinet d'eau et déconnectez-en le tuyau d'arrivée d'eau.
2. Nettoyez le filtre à l'aide d'une brosse.
3. Dévissez le tuyau d'arrivée d'eau du dos de la machine. Sortez le filtre avec une pince à long bec.

4. Nettoyez le filtre à l'aide d'une brosse.
5. Remettez le filtre en place au niveau de l'arrivée d'eau et raccordez à nouveau le tuyau d'arrivée d'eau.
6. Nettoyez le filtre d'arrivée tous les 3 mois pour garantir le bon fonctionnement de l'appareil.

Nettoyage du bac à lessive

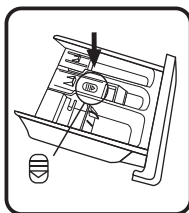

①

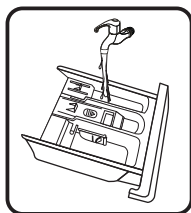

②

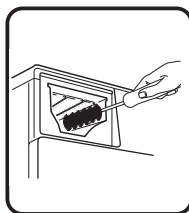

③

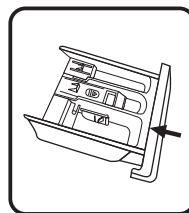

④

1. Appuyez sur le bouton de déblocage [] du couvercle de l'adoucissant, puis sortez le bac à lessive du logement.
2. Soulevez le couvercle de l'adoucissant pour le sortir du bac à lessive et nettoyez le couvercle et le bac à l'eau.
3. Nettoyez l'intérieur du logement à l'aide d'une brosse.
4. Remettez le couvercle de l'adoucissant en place et insérez à nouveau le bac dans le logement.



Remarque :

- N'utilisez pas de produits abrasifs ou caustiques pour nettoyer les pièces en plastique.
- Nettoyez le bac à lessive tous les 3 mois pour garantir le bon fonctionnement de l'appareil.

Nettoyage du filtre de la pompe de vidange



Avertissement !

- Assurez-vous que le programme de lavage est terminé et que la machine est vide. Éteignez la machine et débranchez-la avant de nettoyer le filtre de la pompe de vidange.
- Faites attention à l'eau chaude. Laissez l'eau refroidir. Risque de brûlure !
- Nettoyez le filtre périodiquement tous les 3 mois pour garantir le bon fonctionnement du lave-linge.

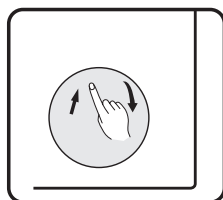

①

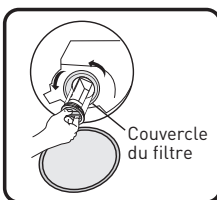

②

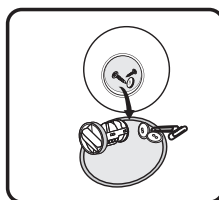

③

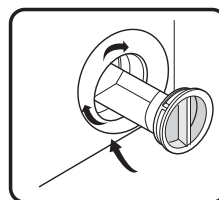

④

1. Ouvrez le couvercle inférieur.
2. Ouvrez le filtre en tournant dans le sens des aiguilles d'une montre.
3. Retirez les corps étrangers.
4. Fermez le couvercle inférieur.



Attention !

- Quand l'appareil est cours d'utilisation et selon le programme sélectionné, il peut y avoir de l'eau chaude dans la pompe. Ne retirez jamais le couvercle de la pompe pendant un programme de lavage. Attendez toujours que l'appareil ait terminé le programme et soit vide. Assurez-vous de serrer fermement le couvercle lorsque vous le remettez en place.

Dépannage

En cas de problème avec l'appareil, vérifiez s'il est possible de le résoudre à l'aide des tableaux ci-dessous. Si le problème persiste, veuillez contacter le service clientèle.

Description	Cause possible	Solution
L'appareil ne se met pas en marche.	<ul style="list-style-type: none"> La porte n'est pas correctement fermée. Des articles sont coincés dans la porte. 	<ul style="list-style-type: none"> Fermez correctement la porte et recommencez. Vérifiez le linge.
Impossible d'ouvrir la porte.	<ul style="list-style-type: none"> La protection de sécurité est activée. 	<ul style="list-style-type: none"> Débranchez l'appareil de la prise électrique et remettez-le en marche.
Il y a une fuite d'eau.	<ul style="list-style-type: none"> Les raccords ne sont pas étanches. 	<ul style="list-style-type: none"> Inspectez le tuyau d'arrivée d'eau et resserrez-le. Vérifiez et nettoyez le tuyau de vidange.
Il y a des résidus de lessive dans le bac à lessive.	<ul style="list-style-type: none"> La lessive est humide et/ou coagulée. 	<ul style="list-style-type: none"> Nettoyez le bac à lessive et séchez-le en l'essuyant.
Les voyants ou l'écran ne fonctionnent pas.	<ul style="list-style-type: none"> Problèmes de connexion au niveau du circuit imprimé ou du faisceau de fils. 	<ul style="list-style-type: none"> Éteignez l'alimentation et vérifiez si la fiche d'alimentation est correctement branchée.
Bruit anormal	<ul style="list-style-type: none"> Les vis de blocage sont toujours en place. Le sol n'est pas ferme ni plat. 	<ul style="list-style-type: none"> Vérifiez que les vis de blocage ont été retirées. Assurez-vous que l'appareil est installé sur un sol ferme et plat.
Codes d'erreur		
E30	<ul style="list-style-type: none"> La porte n'est pas correctement fermée. 	<ul style="list-style-type: none"> Fermez correctement la porte et recommencez.
E10	<ul style="list-style-type: none"> Problème d'injection d'eau pendant le programme de lavage. 	<ul style="list-style-type: none"> Vérifiez si la pression de l'eau est assez élevée. Redressez le tuyau d'eau. Nettoyez le filtre de la vanne d'alimentation.

Description	Cause possible	Solution
E21	<ul style="list-style-type: none"> • Temps de vidange de l'eau excessif. 	<ul style="list-style-type: none"> • Vérifiez si le tuyau de vidange est bloqué.
E12	<ul style="list-style-type: none"> • Débordement d'eau 	<ul style="list-style-type: none"> • Redémarrez l'appareil.
EXX	<ul style="list-style-type: none"> • Divers 	<ul style="list-style-type: none"> • Redémarrez l'appareil. Si le problème persiste, veuillez contacter le service clientèle.



Avertissement !

Risque de choc électrique

- N'essayez jamais de réparer un appareil défectueux ou semblant être défectueux. Vous pourriez mettre votre vie, ainsi que celle des futurs utilisateurs de l'appareil, en danger. Seuls des professionnels agréés sont autorisés à effectuer des travaux de réparation sur cet appareil.
- Une réparation incorrecte annulera la garantie et les dommages en résultant ne seront pas couverts !

Transport

ÉTAPES IMPORTANTES LORS DU TRANSPORT DE L'APPAREIL

- Débranchez l'appareil et fermez le robinet d'arrivée d'eau.
- Vérifiez que la porte et le bac à lessive sont bien fermés.
- Retirez le tuyau d'arrivée d'eau et le tuyau de vidange des installations domestiques.
- Laissez l'appareil se vider complètement de l'eau restante (voir le chapitre « Entretien - Nettoyage du filtre de la pompe de vidange »).
- Important : Remettez les 4 vis de transport en place au dos de l'appareil.
- Cet appareil est lourd. Transportez-le avec précaution. Ne tenez jamais une pièce saillante de la machine lorsque vous la soulevez. La porte de l'appareil ne doit pas être utilisée comme une poignée.

Fiche produit

Nom du fournisseur ou marque de commerce^{(a),(c)} :

Adresse du fournisseur^{(a),(c)} :

Identifiant du modèle^(a) : WF 612 C W566C2

Paramètres généraux du produit :

Paramètre	Valeur		Paramètre	Valeur	
Capacité nominale ^(b) (kg)	6,0		Dimensions en cm ^{(a),(c)}	Taille	85
				Largeur	60
				Profondeur	40
Indice d'efficacité énergétique ^(b) [EEI _w]	68,4		Classe d'efficacité énergétique ^(b)	C ^(d)	
Indice d'efficacité de lavage ^(b)	1,031		Efficacité du rinçage (g/kg) ^(b)	5,0	
Consommation électrique en kWh par cycle, basée sur le programme ÉCO 40-60. La consommation électrique réelle dépendra des conditions d'utilisation de l'appareil.	0,554		Consommation d'eau en litres par cycle, basée sur le programme ÉCO 40-60. La consommation d'eau réelle dépendra des conditions d'utilisation de l'appareil et de la dureté de l'eau.	43	
Température maximale à l'intérieur du textile traité ^(b) (°C)	Capacité nominale	38	Teneur en humidité restante pondérée ^(b) (%)	62,9	
	Moitié	31			
	Quart	27			
Vitesse d'essorage ^(b) (tr/min)	Capacité nominale	1150	Classe d'efficacité d'essorage ^(b)	C ^(d)	
	Moitié	1150			
	Quart	1150			
Durée du programme ^(b) (h:min)	Capacité nominale	3:18	Type	Pose libre	
	Moitié	2:36			
	Quart	2:36			

Fiche produit

Émissions de bruit acoustique aérien pendant la phase d'essorage ^(a) (dB(A) re 1 pW)	76	Classe d'émissions de bruit acoustique aérien ^(b) (phase d'essorage)	B ^(d)
Mode Arrêt (W) (le cas échéant)	0,50	Mode Veille (W) (le cas échéant)	N/A
Départ différé (W) (le cas échéant)	4,00	Veille connectée (W) (le cas échéant)	N/A

Durée minimale de la garantie offerte par le fournisseur^{(a),(c)} :

Ce produit a été conçu pour libérer des ions argent pendant le cycle de lavage.

NON

Informations supplémentaires :

Lien web vers le site Internet du fournisseur, où se trouvent les informations du point 9 de l'annexe II du règlement de la Commission (UE) 2019/2023 (1) :

^(a) Ce produit ne doit pas être considéré comme pertinent aux fins de l'article 2(6) du règlement (UE) 2017/1369.

^(b) Pour le programme ÉCO 40-60.

^(c) Les changements apportés à ce produit ne doivent pas être considérés comme pertinents aux fins du paragraphe 4 de l'article 4 du règlement (UE) 2017/1369.

^(d) Si la base de données du produit génère le contenu définitif de cette cellule de façon automatique, le fournisseur ne doit pas entrer ces données.

¹⁾ La consommation électrique réelle dépendra des conditions d'utilisation de l'appareil.

²⁾ La consommation d'eau réelle dépendra des conditions d'utilisation de l'appareil et de la dureté de l'eau.

³⁾ Les pièces de rechange sont livrées dans les 15 jours ouvrables suivant réception de la commande.

Fiche technique du produit relative aux règlements (UE) 2019/2014

La fiche technique de votre appareil peut être consultée en ligne.

Rendez-vous sur <https://eprel.ec.europa.eu> puis entrez l'identifiant du modèle de votre appareil afin de télécharger la fiche technique.

L'identifiant du modèle de votre appareil se trouve dans la section des spécifications techniques.



Bedankt!

Proficiat met uw keuze voor een product van VALBERG. De selectie en de testen van de toestellen van VALBERG gebeuren volledig onder controle en supervisie van ELECTRO DEPOT. We staan garant voor de kwaliteit van de toestellen van VALBERG, die uitmunten in hun eenvoudig gebruik, hun betrouwbare werking en hun onberispelijke kwaliteit.

ELECTRO DEPOT beveelt de VALBERG toestellen aan en is ervan overtuigd dat u uiterst tevreden zal zijn bij elk gebruik van het toestel. Welkom bij ELECTRO DEPOT.

Bezoek onze website: www.electrodepot.be



ELECTRO DEPOT

60

NL

Inhoudstafel

A

**Overzicht van het
toestel**

Onderdelen
Specificaties

B

**Gebruik van het
toestel**

Installatie
Werking

C

**Reiniging en
onderhoud**

Reiniging en onderhoud
Probleemoplossing
Transport

Productfiche

Onderdelen**A** Bovenblad**B** Bedieningspaneel**C** Netsnoer**D** Trommel**E** Afvoerslang**F** Serviceklep**G** Klepje**H** Wasmiddellade**I** Watertoevoerslang**J** 4x Afdekkappen**K** 1 x Toevoerslang koud water**L** Akoestische spons**Opmerking:**

- De productafbeelding dient alleen ter illustratie, raadpleeg het echte product als referentie.

Specificaties

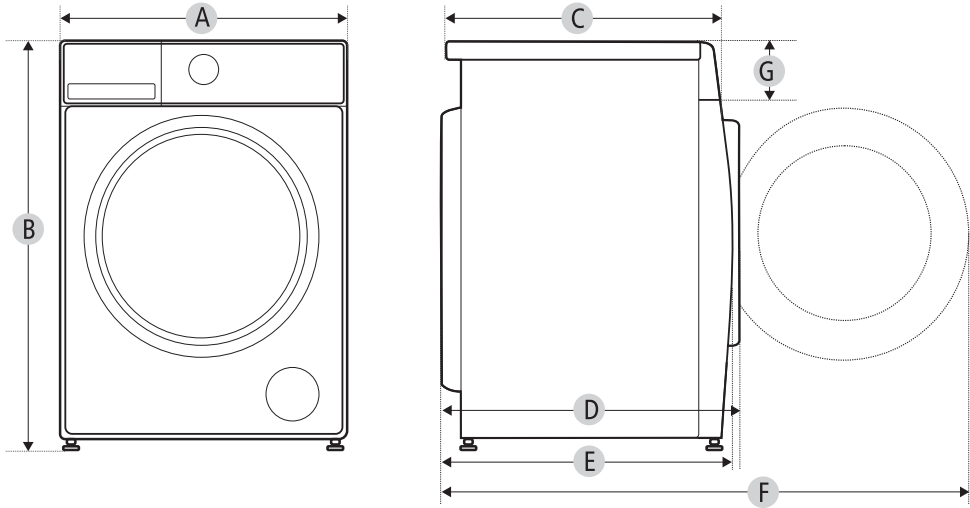

Model:	10003288 - WF 612 C W566C2
Voeding:	220-240V~,50Hz
MAX: Stroom:	10A
Standaard waterdruk:	0,05MPa~1MPa
Wascapaciteit:	6,0 kg

Afmetingen

A:	595mm
B:	850mm
C:	400mm
Gewicht:	55 kg
Nominaal vermogen:	1950W

Referentie-afmetingen

D:	463 mm
E:	421 mm
F:	897 mm
G:	152 mm

Installatie

Installatiegebied

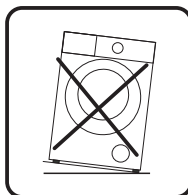
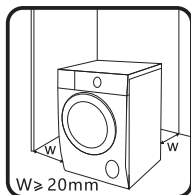

Waarschuwing!

- Stabiliteit is belangrijk om het verschuiven van het product te vermijden! Zorg ervoor dat de machine waterpas en stabiel staat.
- Zorg ervoor dat het product niet op het netsnoer staat.
- Zorg ervoor dat u de minimale afstand tot de muur aanhoudt, zoals weergegeven in de afbeelding.

Alvorens de machine te installeren, zoek naar een locatie die aan de volgende eigenschappen voldoet:

- Harde, droge en vlakke ondergrond
- Vermijd direct zonlicht
- Voldoende ventilatie
- Kamertemperatuur is hoger dan 0°C
- Blijf uit de buurt van warmtebronnen, zoals een apparaat die kool of gas verbrandt.

De wasmachine uitpakken

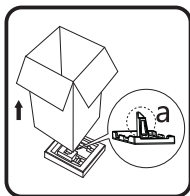

Waarschuwing!

- Verpakkingsmateriaal (bijv. folie, piepschuim) kan gevaarlijk zijn voor kinderen.
- Er bestaat verstikkingsgevaar! Houd alle verpakking uit de buurt van kinderen.

1. Verwijder de kartonnen doos en de piepschuimverpakking.

2. Til de wasmachine op en verwijder de verpakking onderaan. Zorg ervoor dat het kleine driehoekig schuim (a) samen met de verpakking onderaan wordt verwijderd. Als dit niet het geval is, leg het apparaat op zijn zijde en verwijder het handmatig.
3. Verwijder de tape waarmee het netsnoer en de afvoerslang zijn vastgemaakt.
4. Haal de toevoerslang uit de trommel.

De transportbouten verwijderen



Waarschuwing!

- Verwijder de transportbouten aan de achterkant alvorens het product te gebruiken.

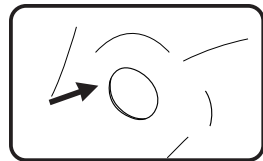
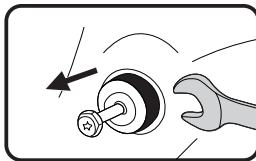
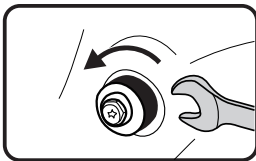

1. Draai de 4 transportbouten los met een steeksleutel.
2. Verwijder de bouten samen met de rubberen delen en bewaar ze voor toekomstig gebruik.
3. Sluit de gaten met de afdekkappen.

De wasmachine waterpas zetten



Waarschuwing!

- De borgmoeren op alle vier de voeten moeten stevig tegen de behuizing worden vastgeschroefd.

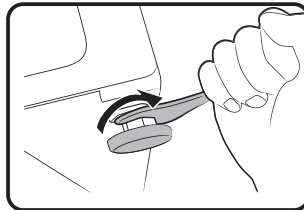

1. Draai de borgmoer los.
2. Draai de voet totdat deze de vloer bereikt.
3. Stel de voeten af en draai de moeren met een steeksleutel vast. Zorg ervoor dat de machine waterpas en stabiel staat.

De watertoevoerslang aansluiten



Waarschuwing!

Volg de instructies in dit hoofdstuk om lekkage of waterschade te voorkomen.

- Zorg dat de watertoevoerslang niet wordt geknikt, geplet of aangepast.

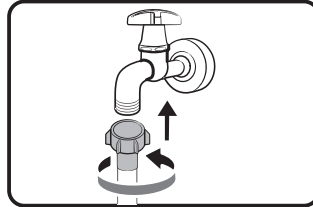
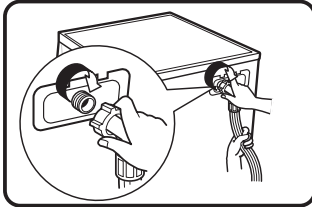

Sluit de watertoevoerslang aan op de waterinlaatklep en een waterkraan met koud water, zoals aangegeven.



Opmerking:

- Sluit handmatig aan en gebruik geen gereedschap. Controleer of de verbindingen stevig zijn vastgemaakt.

Afvoerslang



Waarschuwing!

- De afvoerslang niet knikken of verlengen.
- Plaats de afvoerslang op de juiste manier om schade door waterlekkage te vermijden.

Er zijn twee manieren om het uiteinde van de afvoerslang te plaatsen:

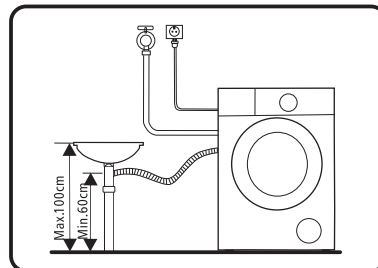
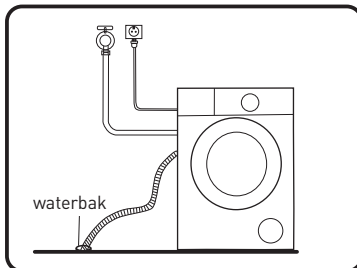

1. Steek de slang in de waterbak.
2. Sluit de slang aan op de afvoerpijp van de bak.

Akoestische spons / paneel



Opmerking:

- Zorg ervoor dat u de akoestische sponzen/paneel aanbrengt, deze verlagen het geluid van de machine tijdens de werking aanzienlijk om u een rustigere en stillere leefomgeving te bieden.

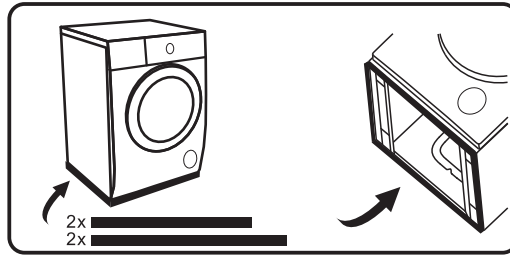

1. Leg de machine op de vloer en breng een zacht materiaal, zoals schuim of doeken, tussen de machine en de vloer aan als bescherming.
2. Plak de 2x langere sponzen op de langere onderste randen van de machine en de 2x kortere sponzen op de kortere onderste randen.

Werking

Snelle start



Voorzichtig!

- Controleer voor het wassen of de wasmachine juist geïnstalleerd is.
- Uw apparaat werd grondig gecontroleerd voordat deze de fabriek heeft verlaten. Om eventueel achtergebleven water te verwijderen en mogelijke geuren te neutraliseren, is het raadzaam om uw apparaat voor het eerste gebruik schoon te maken. Daarom wordt het aanbevolen om de binnentrommel te reinigen met de "TROMMEL REINIGEN" of een ander programma met de optionele temperatuur van 90°C. Pas op dat je geen wasgoed en wasmiddel in de machine doet.



Kalibratie

- Het wordt aanbevolen om de machine te kalibreren zodat de beste prestaties worden verkregen. Het apparaat kan de hoeveelheid toegevoegde wasgoed detecteren. Deze functie optimaliseert de productprestaties door het energie- en waterverbruik te minimaliseren, zodat u geld en tijd bespaart. Om deze reden wordt het aanbevolen om het apparaat te kalibreren voor een optimaal gebruik.
 1. Haal alle accessoires uit de trommel en sluit de deur;
 2. Steek de stekker in het stopcontact;
 3. Schakel de machine in en druk binnen 10 seconden tegelijkertijd op "Uitstel" en "Extra spoelen" (normaal 3 seconden) totdat "t19" wordt weergegeven;
 4. Druk op [DII] om het apparaat te starten, wacht tot "****" wordt weergegeven en vervolgens wordt "***" (zoals "126") weergegeven om de real-time trommelsnelheid aan te geven. Als de machine met succes is gekalibreerd, wordt "PAS" weergegeven, anders wordt "FAL" weergegeven.

- **Voor het wassen**

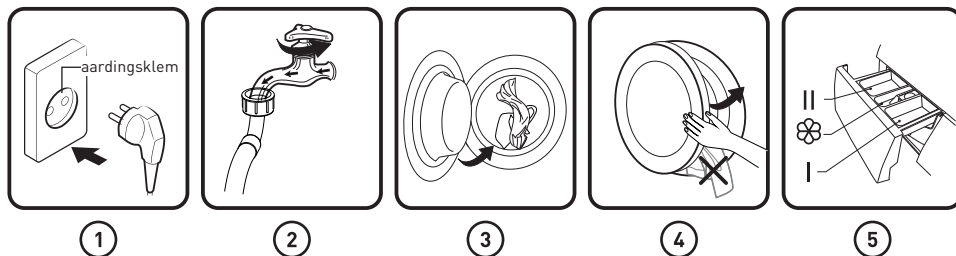

1. Steek de stekker in het stopcontact
2. Draai de kraan open
3. Vullen
4. Deur sluiten
5. Wasmiddel toevoegen

Opmerking:

- Doe wasmiddel in vak I wanneer de voorwasfunctie wordt geselecteerd.
- Zorg er bij het sluiten van de deur voor dat uw kleding niet vast komt te zitten tussen de afdichting en de deur van de machine om waterlekage door het trekken en beschadiging van de afdichting tijdens gebruik te voorkomen.

- **Wassen**

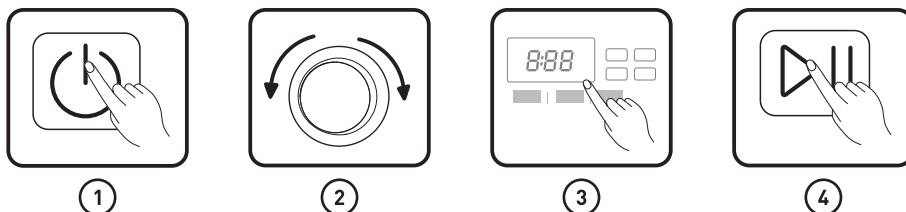

1. Schakel de machine in
2. Selecteer het programma
3. Selecteer de functie selecteren of behoud de standaardinstellingen
4. Op Start/Pauze drukken om het programma te starten

- **Na het wassen**

Zoemer gaat af en "End" (einde) wordt op het display weergegeven.

Voor elke wasbeurt

- De omgevingstemperatuur van de wasmachine moet tussen 5 en 40°C zijn. Bij een gebruik onder 0°C kunnen de inlaatklep en het afvoersysteem beschadigd raken. Als de machine onder vorstomstandigheden wordt geïnstalleerd, moet deze eerst worden overgebracht naar een normale omgevingstemperatuur om ervoor te zorgen dat de watertoevoerslang en afvoerslang voor gebruik kunnen ontdooien.

- Controleer voor het wassen de waslabels en de gebruiksinstructies van uw wasmiddel. Gebruik niet- of beperkt schuimend wasmiddel dat geschikt is voor de wasmachine.

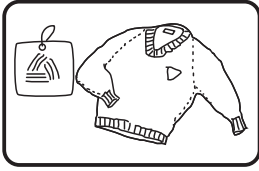

①

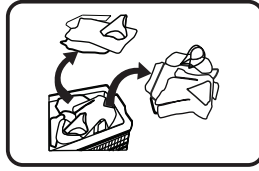

②

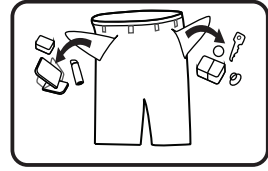

③

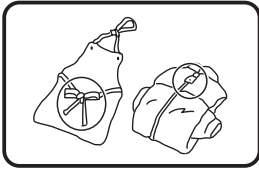

④

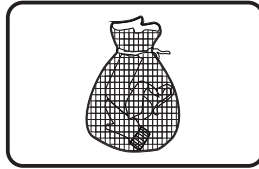

⑤

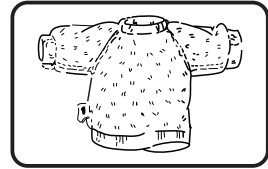

⑥

- Het waslabel controleren
- Het wasgoed op kleur en textielsoort sorteren
- Alle items uit de zakken halen
- Lange textielstroken en riemen vastmaken, en ritsen en knopen sluiten
- Kleine items in een waszak stoppen
- Eenvoudige pluizende en hoogpolige stof binnenstebuiten draaien



Waarschuwing!

- Was geen artikelen die zijn gereinigd, gewassen, gedrenkt in of gedept met brandbare of explosieve stoffen zoals was, olie, verf, benzine, alcohol, kerosine en andere brandbare materialen.
- Het wassen van losse kledingstukken kan gemakkelijk een grote excentriciteit veroorzaken en het alarm laten afgaan als gevolg van een onevenwicht. Daarom wordt het aangeraden om nog een of twee extra stukken wasgoed aan de was toe te voegen zodat het centrifugeren soepel verloopt.
- Was of centrifugeer geen waterdichte zittingen, maten of kleding.

Wasmiddellade

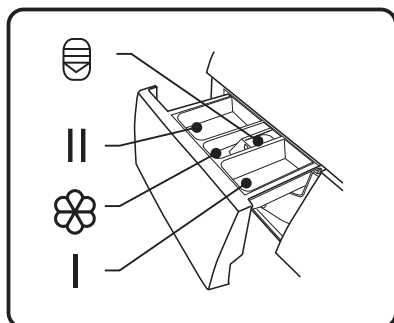

I Voorwas

II Hoofdwash

Wasverzachter

Vrijgaveknop om de lade uit te trekken



Voorzichtig!

- Doe alleen wasmiddel in vak I nadat de voorwasfunctie is geselecteerd.

Bedieningspaneel

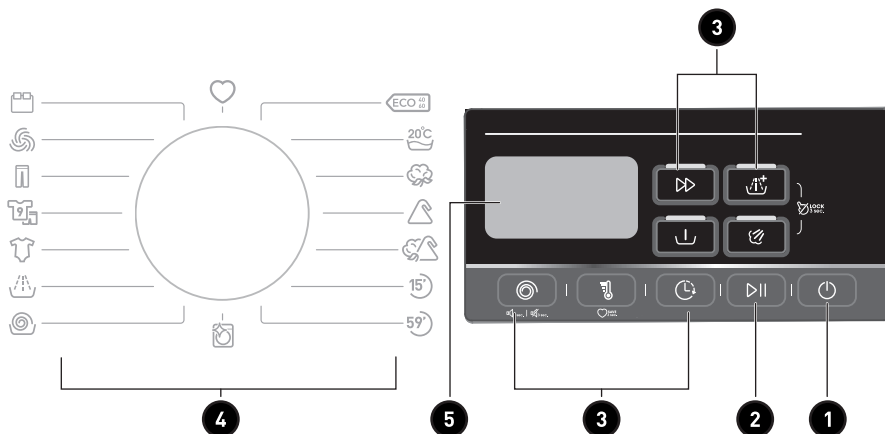
**1** Aan/uit

Zet het apparaat aan en uit.

2 Pauze/start

Start of pauzeer uw programma.





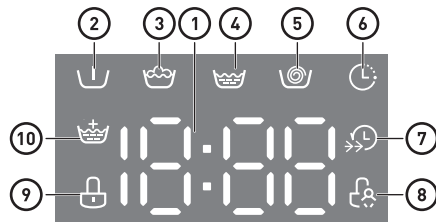











- | | | |
|----------|--------------------|---|
| 3 | Optie | Hiermee kunt u extra functies selecteren. |
| 4 | Programma's | Beschikbaar naargelang het soort wasgoed. |
| 5 | Display | Het scherm toont de instellingen, geschatte resterende tijd, opties en statusberichten. |

Display



- | | | |
|----------|---------------|-----|
| 1 | Display | |
| | • Wastijd | 125 |
| | • Uitsteltijd | 2H |
| | • Snelheid | 400 |
| | • Fout | E30 |
| | • Einde | End |
| | • Temp. | 20 |

- | | |
|-----------|-----------------|
| 2 | Voorwas |
| 3 | Wassen |
| 4 | Spoelen |
| 5 | Centrifuge |
| 6 | Uitstel |
| 7 | Versneld wassen |
| 8 | Kinderslot |
| 9 | Deurslot |
| 10 | Extra spoelen |

Programma	I	II	
 ECO 40-60		●	○
 20°C Zorg+		●	○
 Katoen	○	●	○
 Synthetisch	○	●	○
 Gemengd	○	●	○
 Snel 15'		●	○
 Snel 59'		●	○
 Trommel reinigen			
 Alleen centrifuge			
 Spoelen en centrifugeren			○
 Babyzorg	○	●	○
 Sport	○	●	○
 Jeans	○	●	○
 Wol		●	○
 Dons		●	○

●Verplicht ○Optioneel

Aanbeveling voor soort wasmiddel

Aanbevolen wasmiddel	Wascycli	Wastemp.	Soort wasgoed en textiel
Heavy-duty wasmiddel met bleekmiddel en optisch witmiddel	Katoen	40/60	Witte was van kookvast katoen of linnen
Kleurwasmiddel zonder bleekmiddel en optisch witmiddel	Katoen	20/40	Gekleurd wasgoed van katoen of linnen
Kleur- of mild wasmiddel zonder optisch witmiddel	Katoen, Synthetisch	20/40	Gekleurd wasgoed van onderhoudsvriendelijke vezels of synthetisch materiaal
Mild wasmiddel	Synthetisch	20	Delicaat stoffen, zijde, viscose
Speciaal wolwasmiddel	Wol	20/40	Wol

**Opmerking:**

- Samengeklonterd of stroperig wasmiddel of additief kan in een beetje water worden verdund voordat het in de wasmiddellade wordt gegoten, om te voorkomen dat de inlaat verstopt raakt en er water overloopt.
- Kies het geschikte soort wasmiddel voor maximale wasprestaties en minimaal water- en energieverbruik.
- Voor het beste reinigingsresultaat is een juiste dosering van het wasmiddel belangrijk.
- Gebruik minder wasmiddel wanneer de trommel niet helemaal gevuld is.
- Pas de hoeveelheid wasmiddel altijd aan naargelang de waterhardheid. Als uw leidingwater zacht is, gebruik dan minder wasmiddel.
- Doseer afhankelijk van hoe vuil uw wasgoed is, voor minder vuile kleding hebt u minder wasmiddel nodig.
- Sterk geconcentreerd (compact) wasmiddel vereist een bijzonder nauwkeurige dosering.

De volgende symptomen zijn een teken van een te grote dosis wasmiddel:

- zware schuimvorming
- slecht was- en spoelresultaat





De volgende symptomen zijn een teken van een te lage dosis wasmiddel:

- wasgoed wordt grijs
- kalkaanslag op de trommel, het verwarmingselement en/of het wasgoed

Programma's

Model: 10003288 - WF 612 C W566C2







Programma	Lading (kg)	Weergavetijd
	6,0	6,0
ECO 40-60	6,0	3:18
20°C Zorg+	3,0	1:08
Katoen	6,0	3:39
Synthetisch	3,0	3:18
Gemengd	6,0	1:20
Snel 15'	2,0	0:15
Snel 59'	2,0	0:59
Trommel reinigen	--	1:18
Alleen centrifuge	6,0	0:12
Spoelen en centrifugeren	6,0	0:20
Babyzorg	6,0	2:01

	Sport	3,0	0:47
	Jeans	6,0	1:35
	Wol	2,0	1:07
	Dons	2,5	1:27

**Opmerking:**

- De parameters in deze tabel zijn alleen bedoeld als referentie voor de gebruiker. De werkelijke parameters kunnen verschillen met de parameters die in de bovenstaande tabel zijn vermeld.

WF 612 C W566C

Cyclus	Nominale capaciteit in kg	Temperatuurstelling	Cyclustuur in uren en minuten	Energieverbruik in kWh/bedrijfscyclus	Waterverbruik in liter/bedrijfscyclus	Hoogste temperatuur°C ⁽¹⁾	Restvocht in %/centrifugesnelheid in tpm ⁽²⁾
	6,0	--	3:18	0,781	51,0	38	62,9%/1150
ECO 40-60 ⁽³⁾	3,0	--	2:36	0,450	40,0	31	62,9%/1150
	2,0	--	2:36	0,261	31,0	27	62,9%/1150
 20°C Zorg+	3,0	20	1:08	0,189	41	20	65%/1000
 Katoen	6,0	60	3:44	1,392	65	60	60%/1200
 Gemengd	6,0	40	1:20	0,696	65	40	65%/1000
 Snel 15'	2,0	Koud	0:15	0,030	31	Koud	70%/800
 Babyzorg	6,0	60	2:01	1,212	65	60	65%/1000

- De bovenstaande gegevens dienen alleen ter referentie en de gegevens kunnen wijzigen als gevolg van verschillende werkelijke gebruiksomstandigheden.
- De vermelde waarden voor andere programma's dan het programma ECO 40-60 zijn louter indicatief.
- 20°C kan licht vervuild katoenen wasgoed schoonmaken bij een nominale temperatuur van 20°C, wat voldoet aan de verordening (EU) 2019/2023.
- Voldoet aan EN 60456:2016/prA2019 Met (EU) 2019/2014, (EU) 2019/2023, (EU)2021/340, (EU) 2021/341.

De energie-efficiëntieklasse van de EU is: C

Energie-testprogramma: ECO 40-60. Andere als het standaard programma.

Halve lading voor machine van 6,0 kg: 3,0 kg.

Kwartlading voor machine van 6,0 kg: 2,0 kg.

- ¹⁾ De hoogste temperatuur bereikt door het wasgoed in de wascyclus gedurende minimaal 5 minuten.
- ²⁾ Restvocht na de wasbeurt in procentuele watergehalte en centrifugesnelheid waarbij dit werd bereikt.
- ³⁾ Het programma ECO 40-60 is in staat om normaal vervuild katoenen wasgoed dat wasbaar is verklaard op 40°C of 60°C, samen in dezelfde cyclus te wassen. Dit programma wordt gebruikt om de naleving van de verordening (EU) 2019/2023 te beoordelen.

De meest efficiënte programma's in termen van energieverbruik zijn over het algemeen de programma's die goed presteren bij lagere temperaturen en een langere duur.

Door de huishoudelijke wasmachine te vullen tot de capaciteit die is aangegeven voor de respectievelijke programma's, bespaart u op energie en water.

Het lawaai en het resterend vochtgehalte worden beïnvloed door de centrifugesnelheid: hoe hoger de centrifugesnelheid in de centrifugefase, hoe meer lawaai en hoe lager het resterend vochtgehalte.

















Voorzichtig!

- Als er een stroomonderbreking is terwijl de machine in werking is, dan wordt geselecteerde programma in een speciaal geheugen opgeslagen. De machine gaat door met het programma zodra de stroomvoorziening is hersteld.

Programma's

Programma's zijn beschikbaar naargelang het soort wasgoed.





Programma's		
	ECO 40-60	Geschikt voor normaal vervuild katoenen wasgoed dat wasbaar is op 40°C of 60°C, samen in dezelfde cyclus.
	20°C Zorg+	Kan licht vervuild katoenen wasgoed wassen, bij een nominale temperatuur van 20°C.
	Katoen	Slijtvast textiel, hittebestendig textiel van katoen of linnen.
	Synthetisch	Wassen van synthetische artikelen, zoals overhemden, jassen, gemengde stoffen. Tijdens het wassen van breiwerk moet de hoeveelheid wasmiddel worden verminderd vanwege de losse draadconstructie en het gemakkelijk vormen van bellen.
	Gemengd	Gemengde lading bestaande uit textiel van katoen en synthetisch materiaal.























































	Snel 15'	Extra kort programma, geschikt voor het wassen van licht bevuild en een kleine hoeveelheid wasgoed.
	Snel 59'	Weinig en niet erg vuile kleren snel wassen.
	Trommel reinigen	Speciaal programma om de trommel en buis van de machine te reinigen. Het past een sterilisatie op een hoge temperatuur van 90°C toe om de kleding op een milieuvriendelijkere manier te wassen. Wanneer dit programma wordt uitgevoerd, kunnen er geen kledingstukken of ander wasgoed worden toegevoegd. Wanneer de juiste hoeveelheid chloorbleekmiddel wordt toegevoegd, zal de trommel beter gereinigd worden. De klant kan dit programma regelmatig gebruiken wanneer nodig.
	Alleen centrifuge	Centrifugeert en laat het water weglopen.
	Spoelen en centrifugeren	Spoelt en centrifugeert het wasgoed en laat het water weglopen.
	Babyzorg	Wassen van babykleding om ze schoner te maken en betere spoelprestaties om de babyhuid te beschermen.
	Sport	Sportkleding wassen.
	Jeans	Speciaal voor jeans.
	Wol	Met de hand of in de machine wasbaar textiel (gedeeltelijk) van wol. Zeer zacht wasprogramma om krimpen te voorkomen, langere programmapauzes (textiel rust in het wasmiddel).
	Dons	Dit programma is speciaal ontworpen voor het wassen van donsassen.

**Opmerking:**

- Raadpleeg uw product om de programma's te selecteren.

Optie

	Cyclus	Standaard temp. (°C)	Standaard centrifugesnelheid in tpm	Extra functies
	ECO 40-60	--	--	
	20°C Zorg+	20	1000	 

	Katoen	40	1200	    
	Synthetisch	40	1200	   
	Gemengd	40	1000	    
	Snel 15'	--	800	 
	Snel 59'	30	1000	   
	Trommel reinigen	90	--	
	Alleen centrifuge	--	1000	
	Spoelen en centrifugeren	--	1000	 
	Babyzorg	60	1000	    
	Sport	20	800	  
	Jeans	30	800	    
	Wol	40	600	 
	Dons	40	800	 



Opmerking:

- Voor de maximale centrifugesnelheid, programmatijd en andere details van het ECO 40-60-programma verwijzen wij u naar de inhoud op de Productfiche-pagina.
- De tabel toont u welke cyclus welke instelmogelijkheden biedt.



Centrifuge

Indien nodig kan de centrifugesnelheid worden aangepast door herhaaldelijk op de [Centrifuge] knop te drukken. De snelheid wordt als volgt gewijzigd: 1200: 0-600-800-1000-1200



Uitstel

1. Selecteer een programma
2. Druk op de uitstelknop om een uitsteltijd tussen 0 en 24 uur te kiezen
3. Druk op [Start/Pauze] om de uitgestelde werking te starten



Kies het
programma



Tijd instellen



Start

Om de uitstelfunctie te annuleren, druk op de "Uitstel" knop voordat u het programma start totdat "0 h" op het scherm wordt weergegeven. Als het programma reeds is gestart, schakel het apparaat uit en weer in en selecteer een nieuw programma.



Voorwas

Een extra wasfunctie voordat de hoofdwash begint om de wasprestaties te verhogen.



Opmerking: Het wasmiddel moet worden toegevoegd aan het vak I.



Extra spoelen

Het wasgoed wordt na het selecteren van deze functie extra gespoeld.



Temp.

Indien nodig kan de wastemperatuur worden aangepast door op herhaaldelijk op [Temp.] knop te drukken. De temperatuur wordt als volgt gewijzigd: Koud - 20°C - 30°C - 40°C - 60°C - 90°C.



Stoom

Stoom is van toepassing voor dagelijks wasgoed. De stoom kan diep in de vezel doordringen, waardoor bacteriën en ziektekiemen effectief worden verwijderd, geurtjes worden voorkomen en uw gezondheid wordt beschermd.



Versneld wassen

Deze functie kan de wastijd verkorten.



Mijn Cyclus

Om het vaak gebruikte programma in het geheugen op te slaan. Nadat u het programma hebt gekozen en de opties hebt ingesteld, houd de [Temp.] knop 3 sec. ingedrukt voordat u begint met wassen. De standaardinstelling is Katoen.



Kinderslot

Deze functie is bedoeld om te voorkomen dat kinderen de bedieningselementen op een verkeerde manier gebruiken.



Druk tegelijkertijd gedurende 3 seconden op [Extra spoelen] en [Stoom] totdat de zoemer piept. Het kinderslot-controlelampje brandt.



Voorzichtig!

- Wanneer het kinderslot is geactiveerd, geeft het display afwisselend "CL" en de resterende tijd weer.
- Als u op een andere knop drukt, knippert het kinderslot-controlelampje. Wanneer het programma is afgelopen, wordt "CL" en "End" afwisselend op het display weergegeven.
- Het kinderslot deactiveert de werking van alle knoppen behalve de kinderslotknop! Alleen het gelijktijdig indrukken van de twee knoppen kan het kinderslot deactiveren! Schakel het kinderslot uit voordat u een nieuw programma kiest!



De zoemer dempen



Kies het programma

Houd de [Centrifuge] knop 3 sec. ingedrukt, de zoemer is gedempt.

Om de zoemerfunctie opnieuw te activeren, druk weer 3 seconden op de knop. De instelling blijft behouden tot de volgende terugzetting.



Voorzichtig!

Na het dempen van de zoemerfunctie zijn de geluiden niet langer actief.



Opmerking:

Gebruiksteller

1. Druk op het bedieningspaneel gelijktijdig en ononderbroken op "Speed Wash" en "Delay" gedurende ongeveer 5 seconden. Als het apparaat is ingeschakeld en u drukt tweemaal op "Speed Wash" nadat u een geldige toon hebt gehoord, verschijnen er cijfers op het scherm - de waarde kan de gebruikstijden van het apparaat aangeven.
2. Druk op het bedieningspaneel gelijktijdig en ononderbroken op "Speed Wash" en "Delay" gedurende ongeveer 5 seconden, en de klant kan de normale werking hervatten.

Reiniging en onderhoud



Waarschuwing!

- Haal altijd de stekker uit het stopcontact en draai de waterkraan dicht voordat u het apparaat reinigt en onderhoudt.

De buitenkant schoonmaken

Een juist onderhoud van de wasmachine kan de levensduur verlengen. De buitenkant kan indien nodig worden gereinigd met een verdund, niet-schurend en neutraal reinigingsmiddel. Als er water overloopt, gebruik dan een doek om het onmiddellijk weg te vegen. Gebruik nooit scherpe voorwerpen om het apparaat schoon te maken.



Voorzichtig!

- Gebruik nooit een schurend of bijtend middel, mierenzuur, een verdund oplosmiddel of soortgelijk middel, zoals alcohol of een chemisch product.

De trommel schoonmaken

Roestvlekken die door metalen voorwerpen in de trommel zijn achtergebleven, moeten onmiddellijk worden verwijderd met een chloorvrij reinigingsmiddel. Gebruik nooit staalwol om de trommel schoon te maken!

**Opmerking:**

- Houd tijdens het reinigen van de trommel het wasgoed uit de buurt van de machine.

De deurafdichting en het glas schoonmaken

Veeg het glas en de afdichting na elke wasbeurt schoon om pluis en vlekken te verwijderen. Als er zich pluis ophoopt, kan dit tot lekkage leiden.

Verwijder na elke wasbeurt achterblijvende munten, knopen en andere voorwerpen uit de afdichting.

Reinig de deurafdichting en het glas elke maand om een normale werking van het apparaat te garanderen.

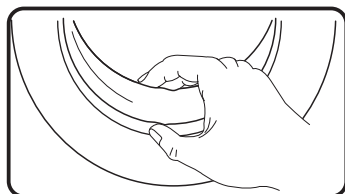
**De inlaatfilter schoonmaken****Opmerking:**

- Een afnemende waterstroom is een teken dat de filter schoongemaakt moet worden.

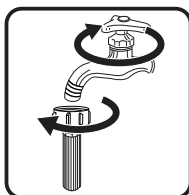

①

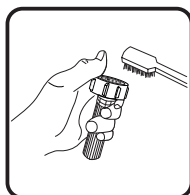

②



③

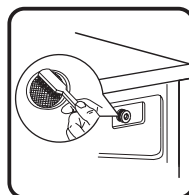

④

1. Draai de kraan dicht en verwijder de watertoevoerslang.
2. Maak de filter schoon met een borstel.
3. Draai de watertoevoerslang los aan de achterkant van de machine. Trek de filter eruit met een platte bektang.

4. Gebruik een borstel om de filter schoon te maken.
5. Plaats de filter terug op de waterinlaat en maak de watertoevoerslang weer vast.
6. Reinig de inlaatfilter elke 3 maanden om een normale werking van het apparaat te garanderen.

De wasmiddellade schoonmaken

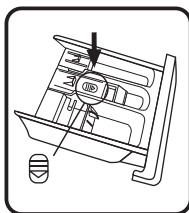

①

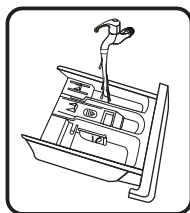

②

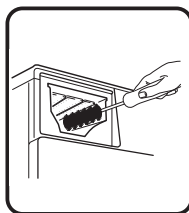

③

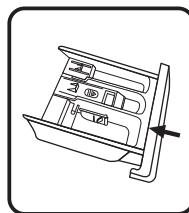

④

1. Duw de ontgrendeling [Ⓜ] op het wasverzachterklepje omlaag en trek de wasmiddellade uit de uitsparing.
2. Til het wasverzachterklepje van de wasmiddellade op en was beide onderdelen in water.
3. Reinig de binnenkant van de uitsparing met een borstel.
4. Plaats het wasverzachterklepje terug en duw de lade terug in de uitsparing.



Opmerking:

- Gebruik geen schurend of bijtend middel om de plastic onderdelen schoon te maken.
- Reinig de wasmiddellade elke 3 maanden om een normale werking van het apparaat te garanderen.

De filter van de afvoerpomp schoonmaken



Waarschuwing!

- Zorg ervoor dat de machine de wascyclus heeft beëindigd en leeg is. Schakel de machine uit en haal de stekker uit het stopcontact voordat u de filter van de afvoerpomp reinigt.
- Wees voorzichtig met heet water. Laat het water afkoelen. Gevaar voor brandwonden!
- Maak de filter regelmatig om de 3 maanden schoon om een normale werking van het apparaat te garanderen.

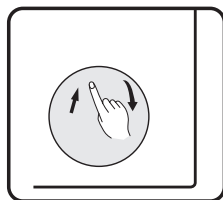

①

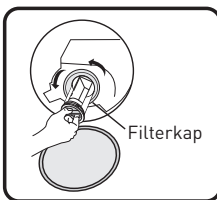

②

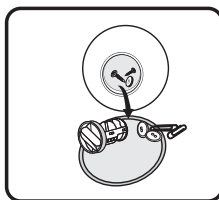

③

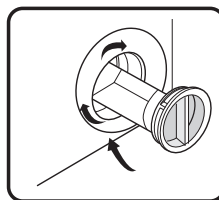

④

1. Open de onderste afdekkap.
2. Open de filter door deze tegen de klok in te draaien.
3. Verwijder vreemde stoffen.
4. Sluit de onderste afdekkap.



Voorzichtig!

- Als het apparaat in gebruik is en afhankelijk van het gekozen programma kan er heet water in de pomp zitten. Verwijder nooit het pompdeksel tijdens een wasprogramma. Wacht altijd totdat het apparaat klaar is met het programma en leeg is. Zorg er bij het terugplaatsen van het deksel voor dat het stevig vastzit.

Probleemoplossing

Wanneer er een probleem is met het apparaat, controleer of u het zelf kunt oplossen aan de hand van de onderstaande tabel. Als het probleem aanhoudt, neem dan contact op met de klantenservice.

Beschrijving	Mogelijke oorzaak	Oplossing
Apparaat start niet	<ul style="list-style-type: none"> • Deur is niet goed dicht. • Kleding zit vast. 	<ul style="list-style-type: none"> • Sluit de deur goed en start opnieuw op. • Controleer het wasgoed.
Deur kan niet worden geopend	<ul style="list-style-type: none"> • De veiligheidsbescherming is geactiveerd. 	<ul style="list-style-type: none"> • Trek de stekker uit het stopcontact en start opnieuw.
Waterlekkage	<ul style="list-style-type: none"> • Verbindingen zijn niet stevig vastgemaakt. 	<ul style="list-style-type: none"> • Controleer de watertoevoerleiding en maak deze vast. • Controleer en reinig de afvoerslang.
Wasmiddelresten in de wasmiddellade.	<ul style="list-style-type: none"> • Wasmiddel is vochtig en/of klonterig. 	<ul style="list-style-type: none"> • Reinig en veeg de wasmiddellade droog.
Controlelampje of display werkt niet	<ul style="list-style-type: none"> • Printplaat of kabelboom heeft verbindingproblemen. 	<ul style="list-style-type: none"> • Schakel de stroom uit en controleer of de stekker goed is aangesloten.
Abnormaal geluid	<ul style="list-style-type: none"> • Zitten de bevestigingsbouten nog steeds op hun plaats. • De vloer is niet stevig of vlak. 	<ul style="list-style-type: none"> • Controleer of de bevestigingsbouten zijn verwijderd. • Zorg ervoor dat het apparaat op een stevige en vlakke vloer staat.

Foutcodes

E30	<ul style="list-style-type: none"> • Deur is niet goed dicht 	<ul style="list-style-type: none"> • Sluit de deur goed en start opnieuw op.
E10	<ul style="list-style-type: none"> • Probleem met watertoevoer tijdens de wascyclus. 	<ul style="list-style-type: none"> • Controleer of de waterdruk voldoende hoog is. • Maak de waterleiding recht. Reinig de filter van de inlaatklep.
E21	<ul style="list-style-type: none"> • Het afvoeren van het water duurt erg lang 	<ul style="list-style-type: none"> • Controleer de afvoerslang op mogelijke verstopping.
E12	<ul style="list-style-type: none"> • Er loopt water over 	<ul style="list-style-type: none"> • Start het apparaat opnieuw.

Beschrijving	Mogelijke oorzaak	Oplossing
EXX	<ul style="list-style-type: none"> • Overige 	<ul style="list-style-type: none"> • Start het apparaat opnieuw. Als het probleem aanhoudt, neem dan contact op met de klantenservice.



Waarschuwing!

Risico op elektrische schokken

- Probeer nooit een apparaat te repareren dat (vermoedelijk) defect is. U kunt uw eigen leven en dit van toekomstige gebruikers in gevaar brengen. Alleen geautoriseerde vakmensen mogen deze reparatiewerkzaamheden uitvoeren.
- Een verkeerde reparatie maakt de garantie ongeldig en gevolgschade kan niet worden erkend!

Transport

BELANGRIJKE STAPPEN BIJ HET VERPLAATSEN VAN HET APPARAAT

- Haal de stekker uit het stopcontact en draai de watertoevoerkraan dicht.
- Controleer of de deur en de wasmiddellade goed gesloten zijn.
- Verwijder de watertoevoerleiding en de afvoerslang van de installaties in uw woning.
- Laat het water volledig uit het apparaat lopen (zie 'De filter van de afvoerpomp schoonmaken').
- Belangrijk: Breng de 4 transportbouten opnieuw aan in de achterkant van het apparaat.
- Dit apparaat is zwaar. Wees voorzichtig tijdens het transport. Houd nooit een uitstekend deel van de machine vast tijdens het optillen. De deur van de machine kan niet als handgreep worden gebruikt.

Productfiche

Naam of handelsmerk van de leverancier^{(a),(c)}:

Adres van leverancier^{(a),(c)}:

Typeaanduiding^(a): WF 612 C W566C2

Algemene productparameters:

Parameter	Waarde		Parameter	Waarde	
Nominiaal vermogen ^(b) (kg)	6,0		Afmetingen in cm ^{(a),(c)}	Hoogte	85
				Breedte	60
				Diepte	40
Energie-efficiëntie-index ^(b) (EEI _W)	68,4		Energie-efficiëntieklasse ^(b)	C ^(d)	
Wasefficiëntie-index ^(b)	1,031		Spoeefficiëntie (g/kg) ^(b)	5,0	
Energieverbruik in kWh per cyclus, gebaseerd op het eco 40-60-programma. Het werkelijk energieverbruik hangt af van hoe het apparaat wordt gebruikt.	0,554		Waterverbruik in liter per cyclus, gebaseerd op het eco 40-60-programma. Het werkelijk waterverbruik hangt af van hoe het apparaat wordt gebruikt en van de hardheid van het water.	43	
Maximale temperatuur binnenin het behandelde textiel ^(b) (°C)	Nominale capaciteit	38	Gewogen resterend vochtgehalte ^(b) (%)	62,9	
	Half	31			
	Kwart	27			
Centrifugesnelheid ^(b) (tpm)	Nominale capaciteit	1150	Centrifuge-efficiëntieklasse ^(b)	C ^(d)	
	Half	1150			
	Kwart	1150			
Programmaduur ^(b) (u:min)	Nominale capaciteit	3:18	Type	vrijstaand	
	Half	2:36			
	Kwart	2:36			

Productfiche

Geluidsemissie via de lucht in de centrifugefase ^(a) (dB(A) re 1 pW)	76	Geluidsemissie via de lucht-klasse ^(b) (centrifugefase)	B ^(d)
Uit-modus (W) (indien van toepassing)	0,50	Standby-bymodus (W) (indien van toepassing)	NVT
Uitgestelde start (W) (indien van toepassing)	4,00	Netwerkgebonden stand-by (W) (indien van toepassing)	NVT
Minimale duur van de door de leverancier geboden garantie^{(a),(c)}:			
Dit product is ontworpen om zilverionen tijdens de wascyclus vrij te geven		NEE	

Aanvullende informatie:

Weblink naar de website van de leverancier, waar de informatie in punt 9 van Bijlage II bij Verordening (EU) 2019/2023 van de Commissie (1) te vinden is:

^{a)} dit item wordt niet relevant geacht voor de toepassing van artikel 2(6) van Verordening (EU) 2017/1369.

^{b)} voor het eco 40-60-programma.

^{c)} wijzigingen in dit item worden niet relevant geacht voor de toepassing van artikel 4, lid 4, van Verordening (EU) 2017/1369.

^{d)} als de productendatabank automatisch de definitieve inhoud van deze cel genereert, zal de leverancier deze gegevens niet invoeren.

- ¹⁾ Het werkelijk energieverbruik is afhankelijk van hoe het apparaat wordt gebruikt.
²⁾ Het werkelijk waterverbruik is afhankelijk van hoe het apparaat wordt gebruikt en van de hardheid van het water.
³⁾ Levering van de reserveonderdelen binnen 15 werkdagen na ontvangst van de bestelling.

Productinformatieblad betreffende (EU) 2019/2014

Het productinformatieblad van uw apparaat is online te vinden.

Ga naar <https://eprel.ec.europa.eu> en voer de typeaanduiding voor uw apparaat in om het gegevensblad te downloaden.

De typeaanduiding van uw apparaat vindt u in het gedeelte Technische specificaties.

¡Muchas gracias!

Muchas gracias por haber elegido nuestro producto VALBERG. Seleccionados, testados y recomendados por ELECTRO DEPOT, los productos de la marca VALBERG le aseguran una utilización sencilla, un rendimiento fiable y una calidad incuestionable.

Con este dispositivo puede estar seguro de que siempre quedará satisfecho al utilizarlo. Le damos la bienvenida a ELECTRO DEPOT.

Visite nuestra página web: www.electrodepot.es



ELECTRO DEPOT

88

ES

A

**Descripción del
aparato**

Partes
Especificaciones

B

**Utilización del
aparato**

Instalación
Funcionamiento

C

**Limpieza y
mantenimiento**

Limpieza y mantenimiento
Solución de problemas
Transporte

Ficha del producto

Partes**A** Tapa superior**B** Panel de control**C** Cable de alimentación**D** Tambor**E** Tubo de desagüe**F** Tapa de mantenimiento**G** Puerta**H** Dispensador de detergente**I** Manguera de suministro de agua**J** 4 tapas**K** 1 manguera de suministro de agua fría**L** Esponja acústica**Nota:**

- La imagen del producto tiene fines meramente ilustrativos, consulte el producto real como referencia.

Especificaciones

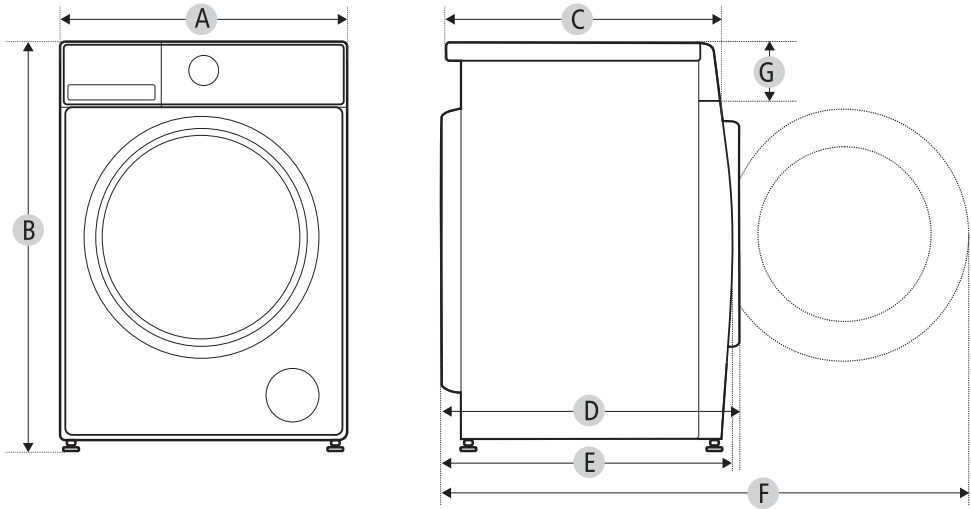

Modelo:	10003288 - WF 612 C W566C2
Alimentación:	220-240V~, 50 Hz
Corriente máx.:	10 A
Presión de agua estándar:	0,05 MPa ~ 1 MPa
Capacidad de lavado:	6,0 kg

Dimensiones

A:	595 mm
B:	850 mm
C:	400 mm
Peso:	55 kg
Potencia nominal:	1950 W

Dimensiones de referencia:

D:	463 mm
E:	421 mm
F:	897 mm
G:	152 mm

Instalación

Zona de instalación

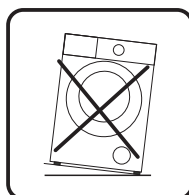
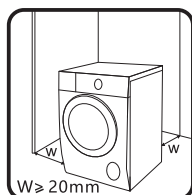

¡Advertencia!

- ¡La estabilidad es importante para evitar que el producto se desplace! Asegúrese de que la lavadora esté en posición vertical, nivelada y estable.
- Asegúrese de que el producto no esté colocado sobre el cable de alimentación.
- Asegúrese de mantener las distancias mínimas de las paredes como se muestra en la imagen.

Antes de instalar la lavadora, se seleccionará la ubicación caracterizada como sigue:

- Superficie rígida, seca y nivelada
- Evite la luz solar directa
- Ventilación suficiente
- Temperatura ambiente superior a 0 °C
- Manténgalo alejado de las fuentes de calor, como el carbón o los aparatos de combustión de gas.

Desembalar la lavadora

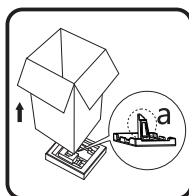

¡Advertencia!

- El material de embalaje (por ejemplo: películas, espuma de poliestireno) puede ser peligroso para los niños.
- ¡Existe riesgo de asfixia! Mantenga todos los materiales de embalaje alejados de los niños.

1. Retire la caja de cartón y el embalaje de espuma de poliestireno.

2. Levante la lavadora y retire el embalaje de la base. Asegúrese de que la espuma triangular pequeña (a) se retire junto con el embalaje inferior. En caso contrario, coloque el aparato sobre su superficie lateral y retírela manualmente.
3. Retire la cinta que sujeta el cable de alimentación y el tubo de desagüe.
4. Saque la manguera de entrada del tambor.

Quite los pernos de transporte



¡Advertencia!

- Deberá quitar los pernos de transporte de la parte posterior antes de usar el producto.

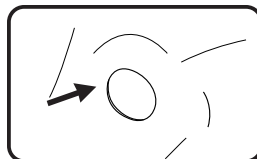
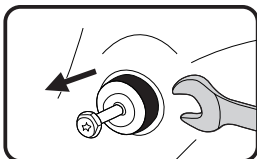
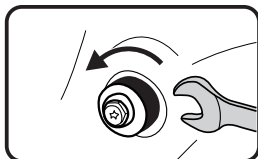

1. Afloje los 4 pernos de transporte con una llave.
2. Retire los pernos, incluyendo las piezas de goma y guárdelos para futuros usos.
3. Cierre los agujeros con las tapas.

Nivelar la lavadora



¡Advertencia!

- Las tuercas de bloqueo de las cuatro patas deberán atornillarse firmemente contra la carcasa.

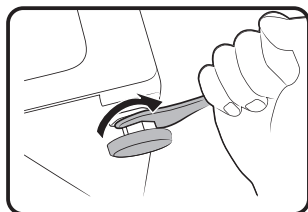

1. Afloje la tuerca de bloqueo.
2. Gire la pata hasta que llegue al suelo.
3. Ajuste las patas y bloquee las tuercas con una llave. Asegúrese de que la lavadora esté nivelada y estable.

Conecte la manguera de suministro de agua**¡Advertencia!**

Para evitar fugas o daños por agua, siga las instrucciones incluidas en este capítulo.

- No retuerza, aplaste ni modifique la manguera de entrada de agua.

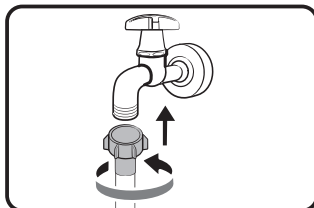
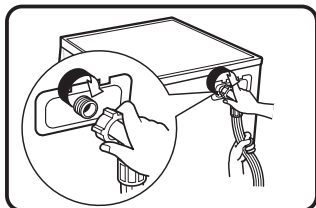

Conecte la manguera de suministro de agua a la válvula de entrada de agua y un grifo de agua fría tal y como se indica.

**Nota:**

- Conéctela manualmente, no use herramientas. Compruebe que las conexiones estén apretadas.

Tubo de desagüe**¡Advertencia!**

- No retuerza ni alargue el tubo de desagüe.
- Coloque el tubo de desagüe correctamente; de lo contrario, se podrían producir daños por fugas de agua.

Hay dos maneras de colocar el extremo del tubo de desagüe:

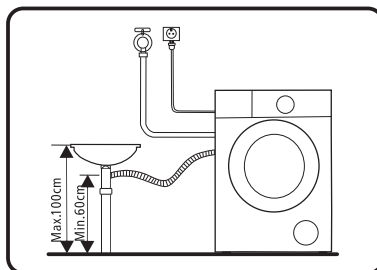
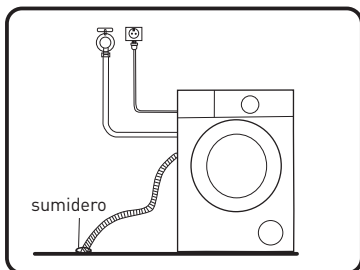

1. Introdúzcalo en el sumidero.
2. Conéctelo a la tubería de desagüe.

Panel/Esponja acústica**Nota:**

- Asegúrese de montar las esponjas acústicas o el panel acústico, que pueden reducir eficazmente el ruido causado por la lavadora durante su funcionamiento, para proporcionarle un ambiente más tranquilo y silencioso.

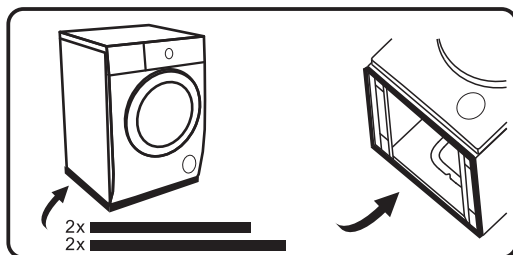

1. Tumbes la lavadora en el suelo, utilizando algún material blando como espuma o ropa entre la lavadora y el suelo para protegerla.
2. Pegue las 2 esponjas más largas en los bordes inferiores más largos de la lavadora; y las 2 esponjas más cortas, en los bordes inferiores más cortos.

Funcionamiento

Inicio rápido



¡Precaución!

- Antes de lavar, asegúrese de que la lavadora esté instalada correctamente.
- Su aparato fue revisado minuciosamente antes de salir de la fábrica. Para eliminar el agua residual y neutralizar los posibles olores, se recomienda limpiar el aparato antes del primer uso. Por esta razón, se recomienda limpiar el tambor interior activando el programa "LIMPIEZA DEL TAMBOR" u otro programa con la temperatura opcional de 90°C. Tenga cuidado de no introducir ropa ni detergente en la lavadora.



Calibración

- Se recomienda calibrar la lavadora para conseguir el mejor rendimiento. El aparato es capaz de detectar la cantidad de ropa introducida. Esta función optimiza el rendimiento del producto minimizando el consumo de energía y agua, ahorrándole dinero y tiempo. Por esta razón, se recomienda calibrar el aparato para utilizarlo de la mejor manera posible.
 1. Saque todos los accesorios del tambor y cierre la puerta.
 2. Inserte el enchufe en la toma de corriente.
 3. Encienda la lavadora y, antes de que transcurran 10 segundos, pulse simultáneamente "Retardo" y "Aclarado extra" (normalmente 3 segundos) hasta que aparezca "t19".
 4. Pulse [▶||] para iniciar el aparato y espere a que se muestre "*****" y, a continuación, "***" (como "126") para indicar la velocidad del tambor en tiempo real. Si la lavadora se ha calibrado correctamente, se mostrará "PAS"; en caso contrario, aparecerá "FAL".

- **Antes del lavado**

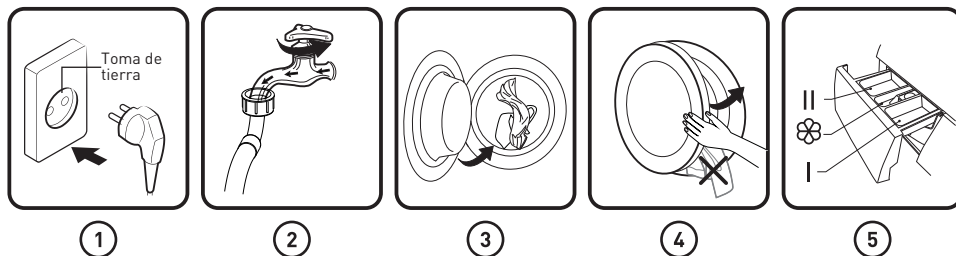

1. Enchufar
2. Abrir el grifo
3. Cargar
4. Cerrar la puerta
5. Añadir el detergente

**Nota:**

- Es necesario añadir detergente en el compartimento I si se selecciona la función de prelavado.
- Al cerrar la puerta, asegúrese de que su ropa no quede atrapada entre el anillo de sellado y la puerta de la lavadora para evitar fugas de agua causadas por tirar del anillo de sellado y dañarlo durante el funcionamiento.

- **Lavado**

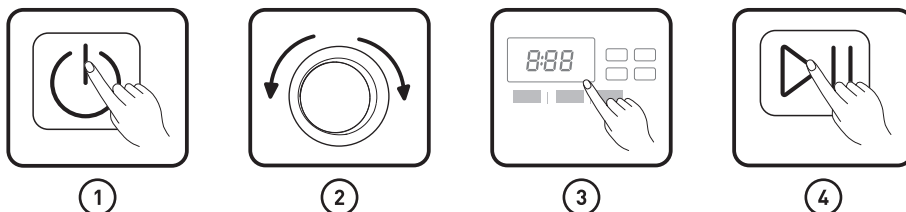

1. Encender
2. Seleccionar el programa
3. Seleccionar la función o mantener los ajustes predeterminados
4. Pulsar Inicio/Pausa para iniciar el programa

- **Después del lavado**

Tono de aviso y aparece "End" en la pantalla.

Antes de cada lavado

- La temperatura ambiente de la lavadora deberá ser de 5-40°C. Si se usa a menos de 0°C, la válvula de entrada y el sistema de desagüe pueden sufrir daños. Si la lavadora está colocada bajo condiciones de congelación, deberá llevarla a un lugar donde haya una temperatura ambiente normal para garantizar que la manguera de suministro de agua y el tubo de desagüe puedan descongelarse antes de su uso.
- Consulte las etiquetas de cuidados de sus prendas y las instrucciones de uso del detergente antes de lavarlas. Utilice detergente no espumante o menos espumante adecuado para lavar a máquina correctamente.

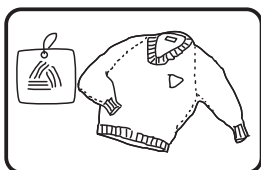

①

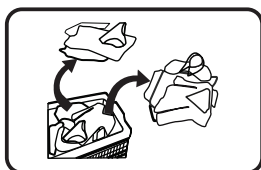

②

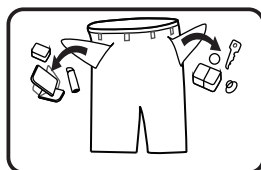

③

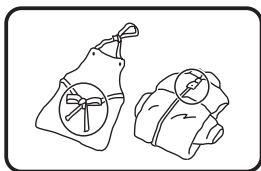

④

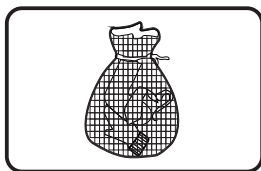

⑤

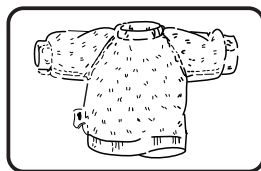

⑥

1. Consulte la etiqueta de cuidados
2. Separe las prendas por color y tipo de tela
3. Saque todos los objetos de los bolsillos
4. Ate los cordones y cinturones largos, cierre las cremalleras y los botones
5. Meta las prendas pequeñas en una bolsa de colada
6. Dé la vuelta a las prendas de pelo largo o que suelten pelusas

**¡Advertencia!**

- No lave prendas que hayan sido limpiadas, lavadas, impregnadas o remojadas en sustancias combustibles o explosivas como cera, aceite, pintura, gasolina, alcohol, queroseno y otros materiales inflamables.
- Lavar una sola prenda puede crear fácilmente una gran excentricidad y provocar una alarma debido al desequilibrio. Por lo tanto, se recomienda añadir una o dos prendas más para lavarlas juntas para que el centrifugado se pueda hacer sin problemas.
- No lave ni centrifugue esterillas, ropa o asientos impermeables.

Dispensador de detergente

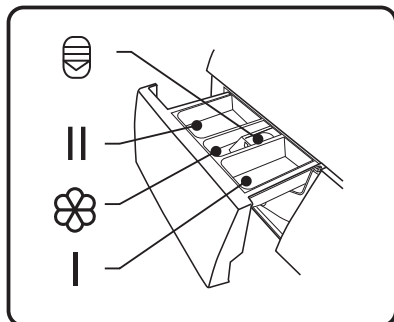

- I Prelavado

- II Lavado principal

- ☼ Suavizante

- 🔒 Botón de liberación para sacar el dispensador



¡Precaución!

- Solo es necesario añadir detergente en el "compartimento I" después de seleccionar la función de prelavado.

Panel de control

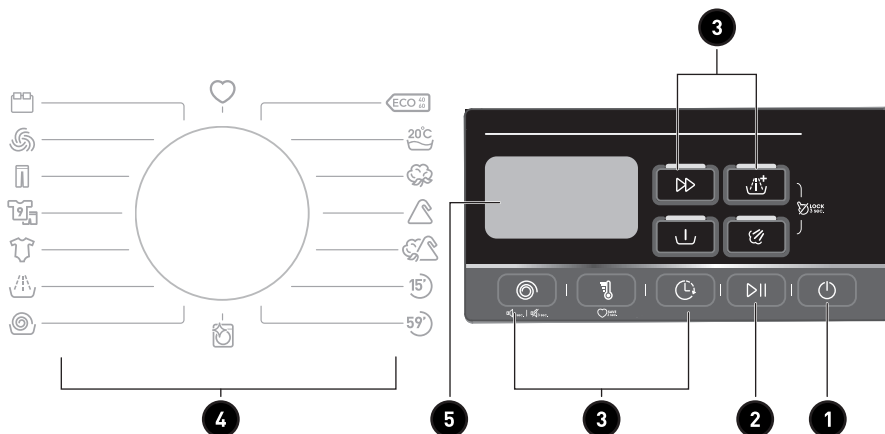

1 Encendido/Apagado Encienda y apague el aparato.

2 Pausa/Inicio Inicie o pause su programa.

3	Opción	Permite seleccionar funciones adicionales.
4	Programas	Disponibles según el tipo de prendas.
5	Pantalla	La pantalla muestra los ajustes, el tiempo restante estimado, las opciones y los mensajes de estado.

Pantalla

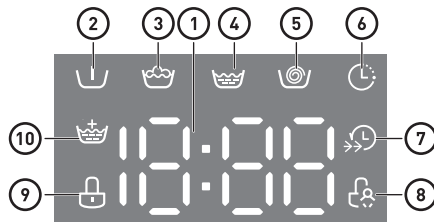

- 1** Pantalla
- Tiempo de lavado 1:25
 - Tiempo de retardo 2H
 - Velocidad 400
 - Error E30
 - Fin End
 - Temperatura 20

2 Prelavado

3 Lavado

4 Aclarado

5 Centrifugado

















6 Retardo

7 Lavado rápido

8 Bloqueo para niños

9 Bloqueo de puerta

10 Aclarado extra

Programa	I	II	
 ECO 40-60		●	○
 20°C Ropa delicada+		●	○
 Algodón	○	●	○
 Sintético	○	●	○
 Mixto	○	●	○
 Rápido 15'		●	○
 Rápido 59'		●	○
 Limpieza del tambor			
 Solo centrifugado			
 Aclarar y centrifugar			○
 Ropa de bebé	○	●	○
 Ropa deportiva	○	●	○
 Vaqueros	○	●	○
 Lana		●	○
 Plumíferos		●	○

● Obligatorio ○ Opcional

Recomendación de detergente

Detergente de lavado recomendado	Ciclos de lavado	Temperatura de lavado	Tipo de prenda y de tela
Detergente fuerte con agentes blanqueadores y blanqueadores ópticos	Algodón	40/60	Prendas blancas de lino o algodón a prueba de ebullición
Detergente para color sin agente blanqueador ni blanqueadores ópticos	Algodón	20/40	Prendas de color de algodón o lino
Detergente para color o suave sin blanqueadores ópticos	Algodón, Sintético	20/40	Ropa de color de fibras de fácil cuidado o materiales sintéticos
Detergente de lavado suave	Sintético	20	Telas delicadas, seda, viscosa
Detergente especial para lana	Lana	20/40	Lana

**Nota:**

- El detergente o aditivo aglomerante o viscoso se puede diluir en un poco de agua antes de echarlo en el dispensador de detergente, para evitar que su entrada se bloquee y provoque un desbordamiento del agua.
- Elija el tipo de detergente adecuado para conseguir el máximo rendimiento de lavado y un mínimo consumo de agua y energía.
- Para lograr el mejor resultado de limpieza es importante una dosificación adecuada del detergente.
- Use una cantidad reducida de detergente si el tambor no está completamente lleno.
- Ajuste siempre la cantidad de detergente a la dureza del agua; si el agua del grifo es blanda, use menos detergente.
- Dosifique según lo sucia que esté la ropa, las prendas menos sucias requieren menos detergente.
- Los detergentes muy concentrados (detergentes compactos) requieren una dosificación especialmente precisa.

Los siguientes síntomas son un signo de sobredosis de detergente:

- formación de espuma espesa
- mal resultado del lavado y aclarado

Los siguientes síntomas son un signo de dosificación insuficiente de detergente:

- las prendas se vuelven grises
- se acumulan depósitos de cal en el tambor, el elemento calefactor y/o la ropa

Programas

Modelo: 10003288 - WF 612 C W566C2

Programa	Carga (kg)	Tiempo de retardo
	6,0	6,0
ECO 40-60	6,0	3:18
20°C Ropa delicada+	3,0	1:08
Algodón	6,0	3:39
Sintético	3,0	3:18
Mixto	6,0	1:20
Rápido 15'	2,0	0:15
Rápido 59'	2,0	0:59
Limpieza del tambor	--	1:18
Solo centrifugado	6,0	0:12
Aclarar y centrifugar	6,0	0:20

B

Utilización del aparato

	Ropa de bebé	6,0	2:01
	Ropa deportiva	3,0	0:47
	Vaqueros	6,0	1:35
	Lana	2,0	1:07
	Plumíferos	2,5	1:27

**Nota:**

- Los parámetros de esta tabla se indican únicamente como referencia para el usuario. Los ajustes reales pueden diferir de los de la tabla anterior.

WF 612 C W566C2

Ciclo	Capacidad nominal en kg	Ajuste de la temperatura	Duración del ciclo en horas y minutos	Consumo de energía en kWh/ciclo de funcionamiento	Consumo de agua en litros/ciclo de funcionamiento	Temperatura máxima °C ⁽¹⁾	Humedad residual en %/velocidad de centrifugado en rpm ⁽²⁾
ECO 40-60 ⁽³⁾	6,0	--	3:18	0,781	51,0	38	62,9%/1150
	3,0	--	2:36	0,450	40,0	31	62,9%/1150
	2,0	--	2:36	0,261	31,0	27	62,9%/1150
20°C Ropa delicada+	3,0	20	1:08	0,189	41	20	65%/1000
Algodón	6,0	60	3:44	1,392	65	60	60%/1200
Mixto	6,0	40	1:20	0,696	65	40	65%/1000
Rápido 15'	2,0	Fría	0:15	0,030	31	Fría	70%/800
Ropa de bebé	6,0	60	2:01	1,212	65	60	65%/1000

- Los datos anteriores se indican solamente como referencia, y los datos pueden cambiar debido a las diferentes condiciones de uso reales.
- Los valores indicados para programas distintos al programa ECO 40-60 son únicamente indicativos.
- 20°C puede lavar prendas de algodón ligeramente sucias, a una temperatura nominal de 20°C, que cumple con el reglamento (UE) 2019/2023.
- Conforme a EN 60456:2016/prA2019 con (UE)2019/2014, (UE)2019/2023, (UE)2021/340,(UE)2021/341

La clase de eficiencia energética de la UE es: C

Programa de pruebas energéticas: ECO 40-60. Otro por defecto.

Media carga para la lavadora de 6,0 kg: 3,0 kg.

Cuarto de carga para la lavadora de 6,0 kg: 2,0 kg.

- ¹⁾ La temperatura más alta alcanzada por la ropa en el ciclo de lavado durante al menos 5 minutos.
- ²⁾ La humedad residual después del ciclo de lavado en el porcentaje del contenido de agua y la velocidad de centrifugado a la que llegó.
- ³⁾ El programa ECO 40-60 puede lavar juntas en el mismo ciclo las prendas de algodón normalmente sucias que se pueden lavar a 40°C o 60°C. Este programa se utiliza para evaluar el cumplimiento del Reglamento (UE) 2019/2023.

Los programas más eficientes en términos de consumo de energía son generalmente los que funcionan a temperaturas más bajas y con una mayor duración.

La carga de la lavadora doméstica hasta la capacidad indicada para los respectivos programas contribuye al ahorro de energía y agua.

El ruido y el contenido de humedad restante están influenciados por la velocidad de centrifugado: cuanto mayor sea la velocidad de centrifugado en la fase de centrifugado, mayor será el ruido y menor el contenido de humedad restante.







¡Precaución!

- Si hay algún corte de alimentación mientras la lavadora está funcionando, una memoria especial guardará el programa seleccionado. La lavadora continuará el programa cuando se restablezca la fuente de alimentación.











Programas

Programas disponibles según el tipo de prendas.

Programas		
	ECO 40-60	Puede lavar juntas en el mismo ciclo las prendas de algodón normalmente sucias que se pueden lavar a 40°C o 60°C.
	20°C Ropa delicada+	Puede lavar la ropa de algodón ligeramente sucia, a una temperatura nominal de 20°C.
	Algodón	Telas muy resistentes o resistentes al calor de algodón o de lino.
	Sintético	Lave prendas sintéticas, por ejemplo: camisas, abrigos o mezclas. Cuando se laven los tejidos de punto, la cantidad de detergente se reducirá debido a su fabricación de hilo suelto y a la fácil formación de burbujas.
	Mixto	Carga mixta compuesta por tejidos de algodón y sintéticos.

B

Utilización del aparato



	Rápido 15'	Programa extracorto aprox., adecuado para lavados con poca suciedad como pequeñas cantidades de ropa.
	Rápido 59'	Lavar rápidamente poca ropa y no muy sucia.
	Limpieza del tambor	Esta lavadora está especialmente diseñada para limpiar el tambor y el tubo. Aplica una esterilización de alta temperatura a 90°C para que el lavado de la ropa sea más ecológico. Cuando se utiliza este programa, no se puede añadir ropa ni otro tipo de lavado. Cuando se coloca la cantidad adecuada de agente blanqueador de cloro, mejora el efecto de limpieza del tambor. Puede utilizar este programa regularmente según sus necesidades.
	Solo centrifugado	Centrifuga y desagua el agua.
	Aclarar y centrifugar	Aclara y luego centrifuga las prendas, y después desagua el agua.
	Ropa de bebé	Lave la ropa de bebé, puede hacer que el bebé lleve la ropa más limpia y mejorar el rendimiento del aclarado para proteger la piel del bebé.
	Ropa deportiva	Lavado de ropa deportiva.
	Vaqueros	Especialmente para vaqueros.
	Lana	Lana lavable a mano o a máquina o textiles de lana rica. Programa de lavado especialmente suave para evitar la contracción, pausas más largas del programa (las telas reposan en la solución de lavado).
	Plumíferos	Este programa está especialmente diseñado para lavar abrigos acolchados.



Nota:

- Consulte su producto para seleccionar los programas.

Opción

Ciclo	Temperatura predeterminada (°C)	Velocidad de centrifugado predeterminada en rpm	Funciones adicionales
 ECO 40-60	--	--	

	20°C Ropa delicada+	20	1000	 
	Algodón	40	1200	    
	Sintético	40	1200	   
	Mixto	40	1000	    
	Rápido 15'	--	800	 
	Rápido 59'	30	1000	   
	Limpieza del tambor	90	--	
	Solo centrifugado	--	1000	
	Aclarar y centrifugar	--	1000	 
	Ropa de bebé	60	1000	    
	Ropa deportiva	20	800	  
	Vaqueros	30	800	    
	Lana	40	600	 
	Plumíferos	40	800	 

**Nota:**

- Para conocer la velocidad máxima de centrifugado, el tiempo del programa y otra información del programa ECO 40-60, consulte el contenido en la página de la Ficha del producto.
- La tabla muestra las opciones de ajuste que ofrece cada ciclo.

**Centrifugado**

Cuando sea necesario, la velocidad de centrifugado se puede ajustar presionando el botón [Centrifugado] en los siguientes pasos: 1200: 0-600-800-1000-1200



Retardo

1. Seleccione un programa
2. Pulse el botón de Retardo para elegir el tiempo de retardo de 0-24H
3. Pulse [Inicio/Pausa] para iniciar la operación de retardo



Seleccione
el programa



Ajuste el tiempo



Iniciar

Para cancelar la función Retardo, pulse el botón "Retardo" antes de iniciar el programa hasta que la pantalla muestre 0 H. Si el programa ya ha comenzado, apague el aparato, vuelva a encenderlo y seleccione un nuevo programa.



Prelavado

Función de lavado extra antes de que comience el ciclo de lavado principal para aumentar el rendimiento de lavado.



Nota: Es necesario añadir detergente en el compartimento I.



Aclarado extra

La ropa se aclarará una vez más después de seleccionar esta función.



Temperatura

Cuando sea necesario, la temperatura de lavado se puede ajustar presionando el botón [Temperatura] en los siguientes pasos: Frío - 20°C - 30°C - 40°C - 60°C - 90°C.



Vapor

El vapor se puede usar para coladas diarias.

El vapor puede penetrar profundamente en la fibra, lo que elimina eficazmente bacterias y gérmenes, previniendo los olores y protegiendo su salud.



Lavado rápido

Esta función puede reducir el tiempo de lavado.



Mi ciclo

Para recordar el programa de uso frecuente.

Después de elegir el programa y ajustar las opciones, pulse el botón [Temperatura] durante 3 segundos antes de empezar a lavar. El ciclo de ajuste predeterminado es Algodón.



Bloqueo para niños

Esta función se utiliza para evitar que los niños hagan un mal uso de los controles.



Pulse [Aclarado extra] y [Vapor] simultáneamente durante 3 segundos hasta que suene el tono de aviso. El indicador del Bloqueo para niños se encenderá.



¡Precaución!

- Cuando el Bloqueo para niños esté activado, la pantalla mostrará alternativamente "CL" y el tiempo restante.
- Cuando pulse cualquier otro botón, el indicador del Bloqueo para niños parpadeará. Cuando finalice el programa, "CL" y "End" se alternarán en la pantalla.
- ¡El Bloqueo para niños desactiva el funcionamiento de todos los botones, excepto el del botón del Bloqueo para niños! ¡Solo la pulsación simultánea de los dos botones puede desactivar el Bloqueo para niños! ¡Desactive el Bloqueo para niños antes de seleccionar un nuevo programa!



Silenciar el tono de aviso



Seleccione el programa



Pulse el botón [Centrifugado] durante 3 segundos, el tono de aviso se silenciará.

Para activar la función del tono de aviso, presione el botón de nuevo durante 3 segundos. El ajuste se mantendrá hasta el siguiente reajuste.



¡Precaución!

Después de silenciar la función del tono de aviso, los sonidos ya no se activarán.



Nota:

Contador de uso

1. Por favor, presione "Lavado rápido" y "Retraso" en el panel de control simultáneamente y continuamente durante aproximadamente 5 segundos. Bajo el estado de encendido, y luego presione "Lavado rápido" dos veces después de escuchar un tono válido, la pantalla del dispositivo muestra dígitos--el valor puede indicar las veces de uso del equipo.
2. Presione "Lavado rápido" y "Retraso" en el panel de control simultáneamente y continuamente durante aproximadamente 5 segundos, y el cliente puede volver a la operación normal.

Limpieza y mantenimiento



¡Advertencia!

- Desenchufe siempre el aparato y cierre el grifo de agua antes de la limpieza y el mantenimiento.

Limpieza de la carcasa

El mantenimiento adecuado de la lavadora puede alargar su vida útil. La superficie se puede limpiar con detergentes neutros no abrasivos diluidos cuando sea necesario. Si hay algún desbordamiento de agua, use un paño para limpiarla inmediatamente. Nunca use objetos afilados para limpiar el aparato.



¡Precaución!

- Nunca use agentes abrasivos o cáusticos, ácidos fórmicos o sus disolventes diluidos o sustancias similares, como alcohol o productos químicos.

Limpieza del tambor

Las manchas de óxido que queden dentro del tambor por los objetos metálicos deben eliminarse inmediatamente usando detergentes sin cloro. ¡Nunca use estropajos metálicos para limpiar el tambor!



Nota:

- Mantenga la ropa alejada de la lavadora mientras limpia el tambor.

Limpieza del cristal y la junta de la puerta

Limpie el cristal y la junta después de cada lavado para eliminar pelusas y manchas. Si se acumulan pelusas, pueden producirse fugas.

Quite todas las monedas, botones y otros objetos que hayan podido quedar en la junta después de cada lavado.

Limpie el cristal y la junta de la puerta cada mes para asegurarse de que el aparato funcione con normalidad.

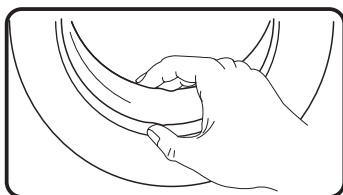

Limpieza del filtro de entrada



Nota:

- La disminución del flujo de agua es una señal de que el filtro debe limpiarse.

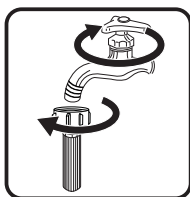

①

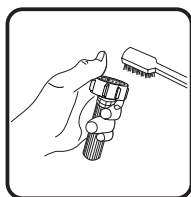

②



③

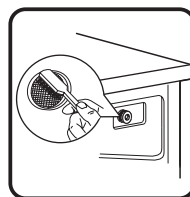

④

1. Cierre el grifo y retire la manguera de suministro de agua del mismo.
2. Limpie el filtro con un cepillo.
3. Desenrosque la manguera de suministro de agua de la parte trasera de la lavadora. Saque el filtro con unos alicates de punta.
4. Utilice un cepillo para limpiar el filtro.
5. Vuelva a colocar el filtro en la entrada de agua y vuelva a conectar la manguera de suministro de agua.

6. Limpie el filtro de entrada cada 3 meses para asegurarse de que el aparato funcione con normalidad.

Limpie el dispensador de detergente

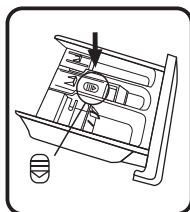

①

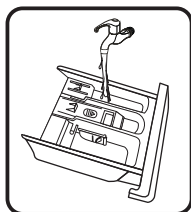

②

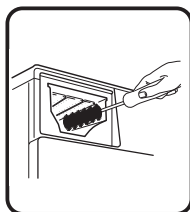

③

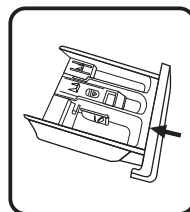

④

1. Presione hacia abajo el botón de liberación [] de la tapa del suavizante y saque de la cavidad el cajón del dispensador.
2. Saque la tapa del suavizante del cajón del dispensador y lave las dos piezas con agua.
3. Limpie el interior de la cavidad con un cepillo.
4. Vuelva a colocar la tapa del suavizante y empuje el cajón dentro de la cavidad.



Nota:

- No utilice agentes abrasivos o cáusticos para limpiar las piezas de plástico.
- Limpie el dispensador de detergente cada 3 meses para asegurarse de que el aparato funcione con normalidad.

Limpieza del filtro de la bomba de desagüe



¡Advertencia!

- Asegúrese de que la lavadora ha terminado el ciclo de lavado y está vacía. Apáguela y desenchúfela antes de limpiar el filtro de la bomba de desagüe.
- Tenga cuidado con el agua caliente. Deje que se enfríe el agua. ¡Riesgo de quemaduras!
- Limpie el filtro periódicamente cada 3 meses para asegurarse de que el aparato funcione con normalidad.

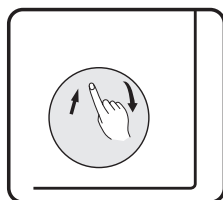

①



②

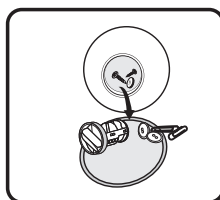

③

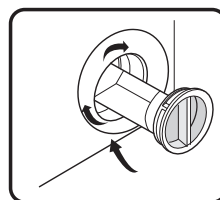

④

1. Abra la tapa inferior.
2. Abra el filtro girándolo en el sentido contrario a las agujas del reloj.
3. Elimine cualquier materia extraña.
4. Cierre la tapa inferior.



¡Precaución!

- Cuando el aparato esté en funcionamiento, y dependiendo del programa seleccionado, puede haber agua caliente en la bomba. Nunca retire la tapa de la bomba durante un ciclo de lavado, espere siempre a que el aparato haya terminado el ciclo y esté vacío. Cuando vuelva a colocar la tapa, asegúrese de que la vuelve a apretar firmemente.

Solución de problemas

Siempre que haya un problema con el aparato, compruebe si puede solucionarlo usted mismo siguiendo las siguientes tablas. Si el problema persiste, póngase en contacto con el servicio de atención al cliente.

Descripción	Posible causa	Solución
El aparato no se inicia	<ul style="list-style-type: none"> • La puerta no está bien cerrada. • La ropa está atascada. 	<ul style="list-style-type: none"> • Cierre la puerta correctamente y reinicie. • Revise la ropa.
No se puede abrir la puerta	<ul style="list-style-type: none"> • La protección de seguridad está activada. 	<ul style="list-style-type: none"> • Desconecte la alimentación y reinicie.

Descripción	Posible causa	Solución
Fugas de agua	<ul style="list-style-type: none"> Las conexiones no están lo suficientemente apretadas. 	<ul style="list-style-type: none"> Revise y deje bien sujeta la manguera de entrada de agua. Revise y limpie la manguera de salida.
Restos de detergente en el dispensador de detergente	<ul style="list-style-type: none"> El detergente está húmedo y/u obstruido. 	<ul style="list-style-type: none"> Limpie y seque el dispensador de detergente.
El indicador o la pantalla no funcionan	<ul style="list-style-type: none"> La placa de circuito impreso o el cableado tienen problemas de conexión. 	<ul style="list-style-type: none"> Apague el aparato y compruebe si el enchufe está conectado correctamente.
Ruido anormal	<ul style="list-style-type: none"> Los pernos de fijación siguen en su posición. El suelo no es firme o no está nivelado. 	<ul style="list-style-type: none"> Compruebe si se han retirado los pernos de fijación. Asegúrese de que el aparato esté instalado sobre un suelo firme y nivelado.
Códigos de error		
E30	<ul style="list-style-type: none"> La puerta no está bien cerrada 	<ul style="list-style-type: none"> Cierre la puerta correctamente y reinicie.
E10	<ul style="list-style-type: none"> Problema de inyección de agua durante el ciclo de lavado. 	<ul style="list-style-type: none"> Compruebe si la presión del agua es lo suficientemente alta. Enderece la manguera de agua. Limpie el filtro de la válvula de entrada.
E21	<ul style="list-style-type: none"> El desagüe del agua tarda demasiado tiempo 	<ul style="list-style-type: none"> Revise el tubo de desagüe por si estuviera obstruido.
E12	<ul style="list-style-type: none"> Desbordamiento del agua 	<ul style="list-style-type: none"> Reinicie el aparato.
EXX	<ul style="list-style-type: none"> Otros 	<ul style="list-style-type: none"> Reinicie el aparato. Si el problema persiste, póngase en contacto con el servicio de atención al cliente.

**¡Advertencia!**

Riesgo de descarga eléctrica

- Nunca intente reparar un aparato que esté defectuoso o presuntamente defectuoso. Podría poner en peligro su propia vida o la de futuros usuarios. Solo los especialistas autorizados pueden realizar estos trabajos de reparación.
- ¡Una reparación incorrecta anulará la garantía y los daños posteriores no podrán ser reconocidos!

Transporte**PASOS IMPORTANTES AL MOVER EL APARATO**

- Desenchufe el aparato y cierre el grifo de entrada de agua.
- Compruebe si la puerta y el dispensador de detergente están cerrados correctamente.
- Retire la manguera de entrada de agua y la manguera de salida de las instalaciones domésticas.
- Desagüe completamente el agua del aparato (consulte el apartado «Mantenimiento y limpieza del filtro de la bomba de desagüe»).
- Importante: Vuelva a instalar los 4 pernos de transporte en la parte trasera del aparato.
- Este aparato es pesado. Transpórtelo con cuidado. Nunca sostenga ninguna parte sobresaliente de la lavadora cuando la levante. La puerta de la lavadora no se puede utilizar como asa.

Ficha del producto

Nombre del proveedor o marca comercial^{(a),(c)}:

Dirección del proveedor^{(a),(c)}:

Identificador del modelo^(a): WF 612 C W566C2

Parámetros generales del producto:

Parámetro	Valor		Parámetro	Valor	
Capacidad nominal ^(b) (kg)	6,0		Dimensiones en cm ^{(a),(c)}	Altura	85
				Anchura	60
				Profundidad	40
Índice de eficiencia energética ^(b) (EEI _w)	68,4		Clase de eficiencia energética ^(b)	C ^(d)	
Índice de eficiencia de lavado ^(b)	1,031		Eficacia del aclarado (g/kg) ^(b)	5,0	
Consumo de energía en kWh por ciclo, basado en el programa eco 40-60. El consumo de energía real dependerá de cómo se utilice el aparato.	0,554		Consumo de agua en litros por ciclo, basado en el programa eco 40-60. El consumo de agua real dependerá de cómo se utilice el aparato y de la dureza del agua.	43	
Temperatura máxima en el interior del textil tratado ^(b) (°C)	Capacidad nominal	38	Contenido ponderado de humedad restante ^(b) (%)	62,9	
	Media carga	31			
	Cuarto de carga	27			
Velocidad de centrifugado ^(b) (rpm)	Capacidad nominal	1150	Clase de eficiencia de secado por centrifugado ^(b)	C ^(d)	
	Media carga	1150			
	Cuarto de carga	1150			

Ficha del producto

Duración del programa ^(b) (h:min)	Capacidad nominal	3:18	Tipo	independiente
	Media carga	2:36		
	Cuarto de carga	2:36		
Emisiones de ruido acústico aéreo en la fase de centrifugado ^(a) (dB(A) re 1 pW)	76	Clase de emisión de ruido acústico aéreo ^(b) (fase de centrifugado)	B ^(d)	
Modo apagado (W) (si procede)	0,50	Modo de espera (W) (si procede)	N/A	
Retardo en el inicio (W) (si procede)	4,00	Modo de espera en red (W) (si procede)	N/A	
Duración mínima de la garantía ofrecida por el proveedor^{(a),(c)}:				
Este producto ha sido diseñado para liberar iones de plata durante el ciclo de lavado			NO	

Más información:

Enlace web al sitio web del proveedor, donde se encuentra la información del apartado 9 del anexo II del Reglamento de la Comisión (UE) 2019/2023 (1):

^(a) este punto no se considerará relevante a efectos del artículo 2, apartado 6, del Reglamento (UE) 2017/1369.

^(b) para el programa eco 40-60.

^(c) las modificaciones de este punto no se considerarán relevantes a efectos del artículo 4, apartado 4, del Reglamento (UE) 2017/1369.

^(d) Si la base de datos de productos genera automáticamente el contenido definitivo de esta celda, el proveedor no introducirá estos datos.

¹⁾ El consumo de energía real dependerá de cómo se utilice el aparato.

²⁾ El consumo de agua real dependerá de cómo se utilice el aparato y de la dureza del agua.

³⁾ Entrega de las piezas de repuesto en un plazo de 15 días laborables tras haber recibido el pedido.

Ficha técnica del producto relativa a (UE) 2019/2014

La ficha técnica del producto para su aparato está disponible en Internet.

Vaya a <https://eprel.ec.europa.eu> e introduzca el identificador del modelo de su aparato para descargar la ficha técnica.

Puede encontrar el identificador del modelo de su aparato en el apartado de especificaciones técnicas.





WARRANTY CONDITIONS

EN

This product is guaranteed against faults caused by defects in manufacturing or the materials used for a period of two years, starting from the date of purchase.* This warranty does not cover defects or damage caused by failure to install the device correctly, incorrect use of the product, or excessive wear and tear.

*proof of purchase required.

CONDITION DE GARANTIE

FR

Ce produit est garanti pour une période de 2 ans à partir de la date d'achat*, contre toute défaillance résultant d'un vice de fabrication ou de matériau. Cette garantie ne couvre pas les vices ou les dommages résultant d'une mauvaise installation, d'une utilisation incorrecte ou de l'usure anormale du produit.

*sur présentation du ticket de caisse.

GARANTIEVOORWAARDEN

NL

Dit product wordt gegarandeerd voor een periode van 2 jaar vanaf de aankoopdatum*, voor elke storing die het gevolg is van een fabricagefout of het materiaal. Gebreken of schade door slechte installatie, onjuist gebruik of abnormale slijtage van het product worden niet gedekt door deze garantie.

*op vertoon van kassabon.

CONDICIONES DE GARANTÍA

ES

El certificado de garantía de este producto tiene una duración de 3 años a partir de la fecha de compra* que se limita a los defectos de fabricación y averías del material. Se excluyen de la garantía deficiencias o daños originados por una mala instalación, errores en la manipulación o por un uso inadecuado.

*previa presentación del comprobante de compra.

ELECTRO DEPOT

1 route de Vendeville

59155 FACHES-THUMESNIL - FRANCE

productsupport@contact.electrodepot.fr

